

# TASCAM

D01160520A

# DR-100mkII

## Linear PCM Recorder

### OWNER'S MANUAL

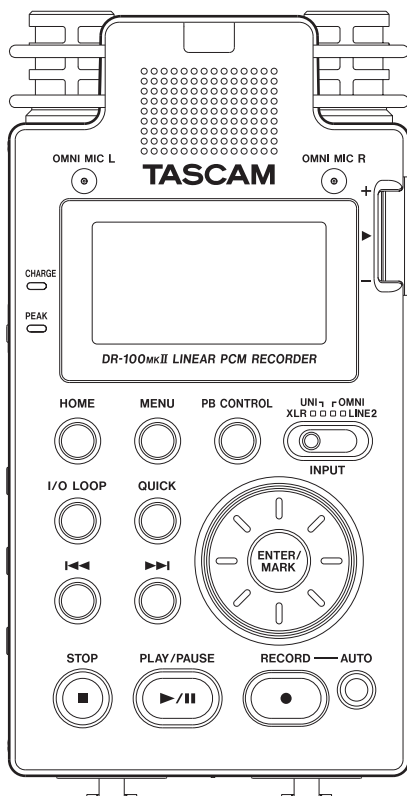

# IMPORTANT SAFETY PRECAUTIONS

## ■ For U.S.A

### TO THE USER

This equipment has been tested and found to comply with the limits for a Class B digital device, pursuant to Part 15 of the FCC Rules. These limits are designed to provide reasonable protection against harmful interference in a residential installation. This equipment generates, uses, and can radiate radio frequency energy and, if not installed and used in accordance with the instruction manual, may cause harmful interference to radio communications. However, there is no guarantee that interference will not occur in a particular installation. If this equipment does cause harmful interference to radio or television reception, which can be determined by turning the equipment off and on, the user is encouraged to try to correct the interference by one or more of the following measures.

- a) Reorient or relocate the receiving antenna.
- b) Increase the separation between the equipment and receiver.
- c) Connect the equipment into an outlet on a circuit different from that to which the receiver is connected.
- d) Consult the dealer or an experienced radio/TV technician for help.

### CAUTION

Changes or modifications to this equipment not expressly approved by TEAC CORPORATION for compliance could void the user's authority to operate this equipment.

### Declaration of Conformity

Model Number : DR-100MKII  
Trade Name : TASCAM  
Responsible party : TEAC AMERICA, INC.  
Address : 7733 Telegraph Road, Montebello,  
California, U.S. A.

Telephone number: 1-323-726-0303

This device complies with Part 15 of the FCC Rules. Operation is subject to the following two conditions:  
(1) this device may not cause harmful interference, and  
(2) this device must accept any interference received, including interference that may cause undesired operation.

This appliance has a serial number located on the rear panel. Please record the model number and serial number and retain them for your records.

Model number \_\_\_\_\_  
Serial number \_\_\_\_\_

## ■ For European Customers

### Disposal of electrical and electronic equipment

- (a) All electrical and electronic equipment should be disposed of separately from the municipal waste stream via designated collection facilities appointed by the government or the local authorities.
- (b) By disposing of the electrical and electronic equipment correctly, you will help save valuable resources and prevent any potential negative effects on human health and the environment.
- (c) Improper disposal of waste equipment can have serious effects on the environment and human health as a result of the presence of hazardous substances in electrical and electronic equipment.
- (d) The crossed out wheeled dust bin symbol indicates that electrical and electronic equipment must be collected and disposed of separately from household waste. 
- (e) The return and collection systems are available to the end users. For more detailed information about disposal of old electrical and electronic equipment, please contact your city office, waste disposal service or the shop where you purchased the equipment.

### Disposal of batteries and/or accumulators

- (a) Waste batteries and/or accumulators should be disposed of separately from the municipal waste stream via designated collection facilities appointed by the government or the local authorities.
- (b) By disposing of waste batteries and/or accumulators correctly, you will help save valuable resources and prevent any potential negative effects on human health and the environment.
- (c) Improper disposal of waste batteries and/or accumulators can have serious effects on the environment and human health as a result of the presence of hazardous substances in batteries and/or accumulators.
- (d) The crossed out wheeled dust bin symbol indicates that batteries and/or accumulators must be collected and disposed of separately from household waste.   
**Pb, Hg, Cd**  
If the battery or accumulator contains more than the specified values of lead (Pb), mercury (Hg), and/or cadmium (Cd) defined in the Battery Directive (2006/66/EC), then the chemical symbols for lead (Pb), mercury (Hg) and/or cadmium (Cd) will be indicated beneath the crossed out wheeled dust bin symbol.
- (e) The return and collection systems are available to the end users. For more detailed information about disposal of waste batteries and/or accumulators, please contact your city office, waste disposal service or the shop where you purchased them.

# IMPORTANT SAFETY INSTRUCTIONS

- 1 Read these instructions.
  - 2 Keep these instructions.
  - 3 Heed all warnings.
  - 4 Follow all instructions.
  - 5 Do not use this apparatus near water.
  - 6 Clean only with dry cloth.
  - 7 Do not block any ventilation openings. Install in accordance with the manufacturer's instructions.
  - 8 Do not install near any heat sources such as radiators, heat registers, stoves, or other apparatus (including amplifiers) that produce heat.
  - 9 Do not defeat the safety purpose of the polarized or grounding-type plug. A polarized plug has two blades with one wider than the other. A grounding type plug has two blades and a third grounding prong. The wide blade or the third prong are provided for your safety. If the provided plug does not fit into your outlet, consult an electrician for replacement of the obsolete outlet.
  - 10 Protect the power cord from being walked on or pinched particularly at plugs, convenience receptacles, and the point where they exit from the apparatus.
  - 11 Only use attachments/accessories specified by the manufacturer.
  - 12 Use only with the cart, stand, tripod, bracket, or table specified by the manufacturer, or sold with the apparatus. When a cart is used, use caution when moving the cart/apparatus combination to avoid injury from tip-over.
- Do not expose this apparatus to drips or splashes.
  - Do not place any objects filled with liquids, such as vases, on the apparatus.
  - Do not install this apparatus in a confined space such as a book case or similar unit.
  - The apparatus draws nominal non-operating power from the AC outlet with its POWER or STANDBY/ON switch not in the ON position.
  - The apparatus should be located close enough to the AC outlet so that you can easily grasp the power cord plug at any time.
  - The mains plug is used as the disconnect device, the disconnect device shall remain readily operable.
  - If the product uses batteries (including a battery pack or installed batteries), they should not be exposed to sunshine, fire or excessive heat.
  - CAUTION for products that use replaceable lithium batteries: there is danger of explosion if a battery is replaced with an incorrect type of battery. Replace only with the same or equivalent type.
  - Caution should be taken when using earphones or headphones with the product because excessive sound pressure (volume) from earphones or headphones can cause hearing loss.



- 13 Unplug this apparatus during lightning storms or when unused for long periods of time.
- 14 Refer all servicing to qualified service personnel. Servicing is required when the apparatus has been damaged in any way, such as power-supply cord or plug is damaged, liquid has been spilled or objects have fallen into the apparatus, the apparatus has been exposed to rain or moisture, does not operate normally, or has been dropped.

# Safety Information

## ■ Cautions about rechargeable batteries

This product uses rechargeable batteries. Misuse of batteries could cause a leak, rupture or other trouble. Always abide by the following precautions when using batteries.

- If a rechargeable battery leaks, do not touch the leaking fluid with a bare hand. Please consult with TEAC Corporation if a battery fluid leak occurs.
- Battery fluid in an eye could result in loss of vision. If fluid enters an eye, wash the eye immediately with clean water. Do not rub the eye when washing. Consult a physician soon after washing. Battery fluid on the body or clothing could cause injuries or burns on the skin. Wash with clean water immediately and then consult a physician.
- Do not use any AC adaptor other than the model designated for use with this unit. Always use the designated AC adaptor when operating the unit or recharging the battery with a household AC power source. Use of an AC adaptor other than the designated one could lead to overheating and cause injury, burns, fires or stains, as well as battery ruptures and battery fluid leaks.
- Do not put a battery into a fire or leave it or recharge it near a fire, under the sun or in other hot conditions.
- Do not disassemble a battery. Doing so could cause electric shock. Please contact the shop where you bought the product or TEAC Corporation if you want to have a battery inspected or repaired. When you want to dispose of the product, please follow the instruction in the Owner's Manual to remove the batteries and recycle the equipment properly.

## ■ Cautions about batteries

- Never recharge non-rechargeable batteries. The batteries could rupture or leak, causing fire or injury.
- When installing batteries, pay attention to the polarity indications (plus/minus (+/-) orientation), and install them correctly in the battery compartment as indicated. Putting them in backward could make the batteries rupture or leak, causing fire, injury or stains around them.

- When you store or dispose batteries, isolate their terminals with insulation tape or something like that to prevent them from contacting other batteries or metallic objects.
- When throwing used batteries away, follow the disposal instructions indicated on the batteries and the local disposal laws.
- Small children may mistakenly swallow a lithium coin battery and it is very dangerous. Keep the battery and the remote control out of the reach of small children. In the event a battery is swallowed, immediately consult a physician.
- Do not use batteries other than those specified. Do not mix and use new and old batteries or different types of batteries together. The batteries could rupture or leak, causing fire, injury or stains around them.
- Do not carry or store batteries together with small metal objects. The batteries could short, causing leak, rupture or other trouble.
- Do not heat or disassemble batteries. Do not put them in fire or water. Batteries could rupture or leak, causing fire, injury or stains around them.
- If the battery fluid leaks, wipe away any fluid on the battery case before inserting new batteries. If the battery fluid gets in an eye, it could cause loss of eyesight. If fluid does enter an eye, wash it out thoroughly with clean water without rubbing the eye and then consult a doctor immediately. If the fluid gets on a person's body or clothing, it could cause skin injuries or burns. If this should happen, wash it off with clean water and then consult a doctor immediately.
- Remove the batteries if you do not plan to use the unit for a long time. Batteries could rupture or leak, causing fire, injury or stains around them. If the battery fluid leaks, wipe away any fluid on the battery compartment before inserting new batteries.
- Do not disassemble a battery. The acid inside the battery could harm skin or clothing.

This Product contains a CR Coin Lithium Battery which contains Perchlorate material - special handling may apply.

See [www.dtsc.ca.gov/hazardouswaste/perchlorate](http://www.dtsc.ca.gov/hazardouswaste/perchlorate)

## ■ For China

产品有毒有害物质或元素的名称及含量

机种: DR-100MKII		有毒有害物质或元素					
	品名	铅 (Pb)	汞 (Hg)	镉 (Cd)	六价铬 (Cr (VI))	多溴联苯 (PBB)	多溴二苯醚 (PBDE)
1	CHASSIS部份	○	○	○	○	○	○
2	PCB Assy部份	×	○	○	○	○	○
3	线材部份	○	○	○	○	○	○
4	附属品部份	×	○	○	○	○	○
5	SEAL部份	○	○	○	○	○	○
6	包装部份	○	○	○	○	○	○
7	Battery部份	○	○	○	○	○	○

○: 表示该有毒有害物质在该部件所有均质材料中的含有量均在 SJ/T11363-2006 标准规定的限量要求以下。

×: 表示该有毒有害物质至少在该部件的某一均质材料中的含量超出 SJ/T11363-2006 标准规定的限量要求。

(针对现在代替技术困难的电子部品及合金中的铅)

<b>IMPORTANT SAFETY PRECAUTIONS .....</b>	<b>2</b>	Preparing an SD card for use .....	24
<b>IMPORTANT SAFETY INSTRUCTIONS .....</b>	<b>3</b>	Using the built-in speaker .....	25
<b>Safety Information .....</b>	<b>4</b>	Connecting monitors and headphones .....	25
<b>Quick Start Guide .....</b>	<b>7</b>	Mode selection .....	25
<b>1 – Introduction .....</b>	<b>9</b>	Setting the mode .....	25
Main features.....	9	Confirming the mode .....	25
Included items .....	9	Restrictions when using HS mode .....	26
Conventions used in this manual .....	9	<b>4 – Recording .....</b>	<b>27</b>
Recycling the lithium ion battery .....	10	Setting the mode .....	27
Intellectual property rights .....	10	Selecting file format, sampling frequency, and maximum file size.....	27
SD cards.....	11	Available recording time display .....	27
Precautions for use .....	11	Setting where files are saved.....	28
Precautions for placement and use .....	11	Setting the analog input .....	28
Beware of condensation .....	11	Recording with the built-in mics (UNI/OMNI).....	28
Cleaning the unit .....	11	Recording with external mics (XLR).....	28
User registration.....	11	Using phantom power .....	29
<b>2 – Names and Functions of Parts .....</b>	<b>12</b>	Recording from external equipment (LINE 1).....	29
Top pane .....	12	Recording from external equipment (LINE 2).....	29
Front panel.....	13	Setting the digital input.....	30
Rear panel.....	13	Making analog input settings .....	30
Left side panel.....	14	Adjusting the analog input level.....	31
Right side panel.....	14	Manually adjusting the analog input level .....	31
Bottom panel .....	14	Using the level control function .....	32
Remote control (TASCAM RC-10).....	15	Recording .....	32
Home screen.....	16	Dividing files and creating new files while recording .	33
Recording screen .....	17	Creating new files manually while recording (track incrementing).....	33
Menu item list .....	18	Creating new files automatically while recording (automatic track incrementing).....	33
Using menus.....	18	Automatically cutting silences during recording ....	33
Basic operation.....	19	Dividing a file manually (DIVIDE) .....	33
<b>3 – Preparation for Use.....</b>	<b>20</b>	Recording playback and input sounds together (overdubbing).....	34
Preparing the power.....	20	Select the file you want to overdub .....	34
Power source options .....	20	Monitoring input signals .....	34
Using the lithium ion battery.....	20	Adjusting the input and playback sound levels.....	34
Using AA batteries .....	20	Recording an overdub.....	34
Using both types of batteries together.....	20	Automatic recording (AUTO REC) .....	35
Using an AC adaptor (sold separately) .....	21	Enabling automatic recording.....	35
Using an external battery pack (sold separately) ....	21	Automatically adding marks when recording (MARK).....	35
Preparing the remote control.....	21	Automatically pausing recording (PAUSE) .....	36
Installing the battery .....	21	Start new files automatically during recording (TRK INC).....	36
When to change the battery .....	21	Mark function.....	36
Cautions about the use of the battery .....	21	Adding marks manually during recording and playback .....	36
Using the remote control (TASCAM RC-10).....	22	Moving to a mark position.....	37
Wireless use .....	22	Clearing Marks .....	37
Wired use .....	22	Recording the moment before pushing RECORD (PRE REC).....	37
Enable wired remote control use .....	22	Delaying the start of recording (REC DELAY).....	37
Precautions for use of the remote control .....	22	Recording duration.....	38
Turning the power on and off .....	23	<b>5 – Working with Files and Folders (BROWSE Screen) .....</b>	<b>39</b>
Starting up the unit.....	23	Screen navigation.....	39
Shutting down .....	23		
Battery settings .....	23		
Setting the date and time.....	23		
Inserting and removing SD cards .....	24		
Inserting the card.....	24		
Removing the card .....	24		
SD card write protection .....	24		

# Contents

Icons on the BROWSE screen.....	39
File operations .....	39
Folder operations.....	40
Add identification tags to files (QUICK TAG) .....	40
Delete the selected file (QUICK DEL) .....	41
<b>6 – Playback .....</b>	<b>42</b>
Selecting files for playback (skip).....	42
Setting the mode.....	42
Adjusting playback volume .....	42
Setting the playback area (AREA) .....	42
Selecting a folder for the playback area (1).....	42
Selecting a folder for the playback area (2).....	43
Playlist.....	43
Adding files to the playlist .....	43
Editing the playlist .....	43
Selecting files for playback (skip).....	44
Playback.....	44
Stopping .....	44
Pausing (PAUSE) .....	44
Rewinding and fast-forwarding (search).....	44
Using the wheel to change the playback position ..	45
Repeat playback (REPEAT) .....	45
Loop playback.....	45
Special playback control functions .....	45
Setting the playback control functions.....	45
Changing speed without changing pitch (VSA function).....	46
Changing playback speed .....	46
<b>7 – Connecting with a Computer .....</b>	<b>47</b>
Connecting a computer .....	47
Transferring files to a computer .....	47
Transferring files from a computer.....	47
Disconnecting from a computer .....	47
Using the INFORMATION screens.....	48
File information page (FILE) .....	48
Card information page (CARD).....	48
System information page (SYSTEM) .....	48
<b>8 – Settings and Information .....</b>	<b>48</b>
Battery information page (BATTERY) .....	49
Operation settings (SETUP) .....	49
Search speed setting .....	49
Automatic power OFF setting .....	49
Automatic backlight OFF setting .....	49
Display contrast setting .....	49
Backlight brightness setting .....	49
Restoring default settings .....	49
Using QUICK FORMAT.....	50
Using FULL FORMAT.....	50
Setting the main battery source (MAIN).....	50
Changing batteries when the power is on.....	50
Setting the type of AA batteries (AA BATTERY) .....	51
Setting the file name format.....	51
File name format .....	51
Setting the file name (WORD) .....	51
<b>9 – Using the REMOTE/DIGITAL IN jack .....</b>	<b>52</b>
Footswitch (TASCAM RC-3F, sold separately) .....	52
Setting footswitch operation.....	52
Using the footswitch.....	52
Using digital input.....	52
Setting the digital input .....	52
<b>10 – Messages .....</b>	<b>54</b>
<b>11 – Troubleshooting .....</b>	<b>56</b>
<b>12 – Specifications .....</b>	<b>57</b>
Ratings.....	57
Input/output ratings.....	57
Analog audio input/output ratings.....	57
Digital audio input ratings.....	57
Control input/output ratings .....	57
Audio performance.....	57
Requirements for connected computers.....	57
General .....	58
Dimensional drawing .....	58

# Quick Start Guide

In this section, we explain how to use this unit to record with the built-in mics (UNI MIC) and how to play back a recording.

The unit contains a factory-installed SD card, and will by default produce 44.1 kHz, 16-bit WAV files.

Higher-quality or longer files can be produced using other recording settings. See “Selecting file format, sampling frequency, and maximum file size” for details on page 27.

- 1 Insert the included TASCAM BP-L2 lithium ion battery into the battery compartment on the side of the recorder. Orient the battery so that it fits in the battery compartment.**

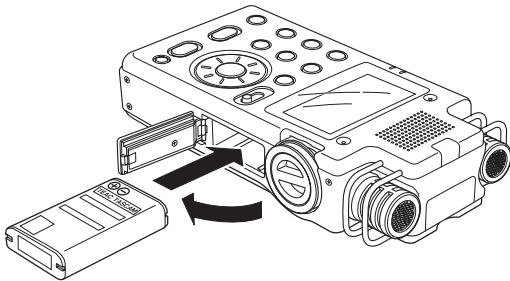

## NOTE

When the product is purchased new, the included TASCAM BP-L2 lithium ion battery has not been charged sufficiently for the operation of the recorder. Charge the battery before using the unit by connecting it with a computer by USB. (See “Using the lithium ion battery” on page 20.)

- 2 Turn on, and various setting information will be displayed.**

Press the **⏻ / |** button on the left side panel until the unit is turned on, and then release it.

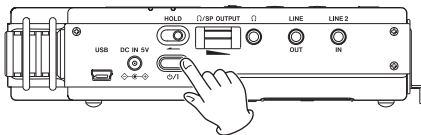

## NOTE

After purchasing the recorder, the first time you turn the power ON, the **DATE/TIME** screen will open in order to enable it to accurately add date and time information to recorded files.



Press the **◀◀** or **▶▶** button to move the cursor (highlighted portion), and adjust the date and time using the wheel. Then press the **ENTER/MARK** button to set. (See “Setting the date and time” on page 23.)

- 3 Set the INPUT switch to UNI.**

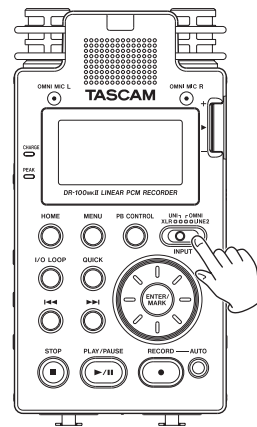

- 4 Press the RECORD [●] button to switch to recording standby. The indicator will flash.**

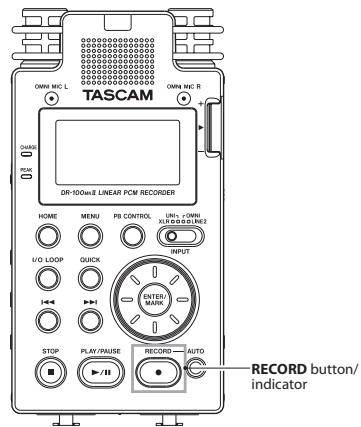

- 5 Use the INPUT knob on the right side panel to adjust the analog input level. See “Adjusting the analog input level” on page 31 for details.**
- 6 Press the RECORD [●] button to start recording. The indicator will light during recording.**
- 7 Press the STOP [■] button to finish recording.**

## NOTE

To pause recording, press the **RECORD [●]** or **PLAY/PAUSE [▶/||]** button. Press the **RECORD [●]** or **PLAY/PAUSE [▶/||]** button again to restart recording in the same file.



# Quick Start Guide

- 8 Press the **PLAY/PAUSE** [▶/||] button for playback. If you use a headphone or external monitor system (powered monitor speakers or amplifier and speakers), connect it to the  $\Omega$  or LINE OUT jack on the left side panel.

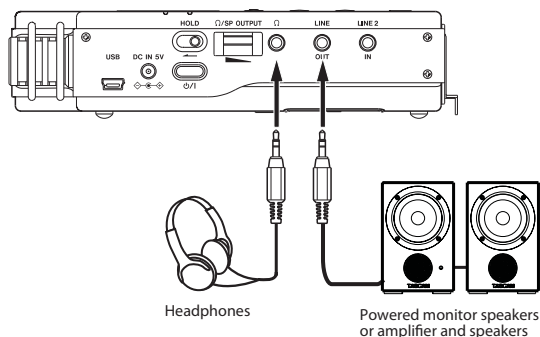

For playback over the built-in speaker, turn the **SPEAKER** switch to **ON** (See “Using the built-in speaker” on page 25.)

## NOTE

When headphones are connected, sound will not be output from the speaker even if the **SPEAKER** switch is **ON**.

- 9 Use the  $\Omega$ /SP OUTPUT volume control to adjust the playback volume.
- 10 Press the **STOP** [■] button to stop playback.

## NOTE

If you have made several recordings, use the ◀◀ or ▶▶ button to select the file to play when playing back or stopped and the Home Screen is displayed.

- 11 To turn the power **OFF**, press and hold the  $\phi$  / | button on the left side panel until **LINEAR PCM RECORDER** appears on the screen. When the recorder is finished shutting down, the power will turn off.



# 1 – Introduction

Thank you very much for purchasing a TASCAM DR-100MKII Linear PCM Recorder.

Before using your unit, please read this manual carefully so that you will understand the correct operating procedures and be able to use all the functions fully. We hope that you will enjoy using this product for many years to come.

Please keep this manual for future reference. You can also download a digital copy from our website (<http://tascam.com/>).

---

## Main features

---

- Uses SD/SDHC cards as storage media for high quality audio recording
- Includes HS mode that supports 44.1 kHz, 48 kHz and 96 kHz sampling frequencies and allows recording and playback at 96 kHz
- Linear PCM (WAV format) recording possible at 44.1 kHz, 48 kHz or 96 kHz and 16-bit or 24-bit (96 kHz supported only in HS mode)
- MP3 format recording possible at 32–320 kbps (STD mode, ID3 tag v2.4 supported)
- 4 total built-in mics include 2 directional mics suitable for high-quality stereo recording and 2 omnidirectional mics optimal for recording meetings and similar events
- 2 lockable XLR mic connectors that can provide +48V phantom power
- Built-in 0.4-W mono speaker
- 2 different types of batteries used together allow for many hours of operation as well as the ability to change batteries while recording
- AUTO REC function allows the unit to start and stop recording automatically by sensing changes in the analog input level
- MARK function allows you to move to specific locations in a recording
- DIVIDE function allows you to split a file at the position you select (WAV files only)
- PRE REC function allows the unit to record the two seconds of sound before recording is activated (pre-recording)
- User words and dates can be set for file names
- Quick Tag function allows you to quickly identify files
- REC DELAY allows you to avoid recording the sound of pushing the **RECORD** [●] button
- Automatic track incrementing creates a new file and continues recording when a file size or input level set in advance is exceeded
- Track incrementing allows the creation of new files at any time during recording without pausing
- Tripod mounting hole built-in
- Wireless remote control (TASCAM RC-10) included with wired remote control adapter and cable
- USB cable, soft case and windscreen included
- 3.5 mm (1/8") line/headphones output jack

- 128 x 64 pixel LCD with backlight
- Mini-B type USB 2.0 port
- Power can be supplied using a TASCAM BP-6AA external battery pack, which meets the specifications of this unit (sold separately)

---

## Included items

---

This product includes the following items.

Take care when opening the package not to damage the items. Keep the package materials for transportation in the future.

Please contact the retailer where you purchased this unit if any of these items are missing or have been damaged during transportation.

- Main unit ..... 1
- SD memory card (installed in the main unit) ..... 1
- TASCAM BP-L2 custom lithium ion battery (including warranty and manual) ..... 1
- USB cable (80 cm)..... 1
- Soft case ..... 1
- Windscreen..... 1
- TASCAM RC-10 Wireless remote control ..... 1
- Coin battery for remote control (installed in remote control)..... 1
- Wired remote control adapter ..... 1
- Wired remote control cable..... 1
- Digital conversion cable ..... 1
- Warranty ..... 1
- Owner's manual (this document)..... 1

---

## Conventions used in this manual

---

The following conventions are used in this manual.

- Buttons and connectors on this device are indicated like this: **MENU**
- Messages on the unit's screen are shown like this: MENU
- Messages that appear on the computer's screen are shown like this: DR-100MKII
- "SD memory card" is sometimes abbreviated as "SD card."
- Additional information is provided as necessary as "tips," "notes" and "cautions."

### TIP

These are tips about how to use the unit.

### NOTE

These provide additional explanations and describe special cases.

### CAUTION

Failure to follow these instructions could result in injury, damage to equipment or lost recording data, for example.

# 1 – Introduction

## Recycling the lithium ion battery

This unit uses a lithium ion battery. When you no longer need the battery please help preserve the valuable resources it contains by returning it to a business that recycles rechargeable batteries.

Please contact a TASCAM sales representative if you have any questions.



Any data, including, but not limited to information, described herein are intended only as illustrations of such data and/or information and not as the specifications for such data and/or information. TEAC Corporation disclaims any warranty that any use of such data and/or information shall be free from infringement of any third party's intellectual property rights or other proprietary rights, and further, assumes no liability of whatsoever nature in the event of any such infringement, or arising from or connected with or related to the use of such data and/or information.

## Intellectual property rights

- TASCAM is a registered trademark of TEAC Corporation.
- SDHC Logo is a trademark of SD-3C, LLC.



- Supply of this product does not convey a license nor imply any right to distribute MPEG Layer-3 compliant content created with this product in revenue-generating broadcast systems (terrestrial, satellite, cable and/or other distribution channels), streaming applications (via Internet, intranets and/or other networks), other content distribution systems (pay-audio or audio-on-demand applications and the like) or on physical media (compact discs, digital versatile discs, semiconductor chips, hard drives, memory cards and the like). An independent license for such use is required. For details, please visit <http://mp3licensing.com>.
- MPEG Layer-3 audio coding technology licensed from Fraunhofer IIS and Thomson.
- Microsoft, Windows, Windows XP, Windows Vista, and Windows 7 are either registered trademarks or trademarks of Microsoft Corporation in the United States and/or other countries.
- Apple, Macintosh, iMac, Mac OS and Mac OS X are trademarks of Apple Inc.
- Other company names, product names and logos in this document are the trademarks or registered trademarks of their respective owners.

This product is designed to help you record and reproduce sound works to which you own the copyright, or where you have obtained permission from the copyright holder or the rightful licensor. Unless you own the copyright, or have obtained the appropriate permission from the copyright holder or the rightful licensor, your unauthorized recording, reproduction or distribution thereof may result in severe criminal penalties under copyright laws and international copyright treaties. If you are uncertain about your rights, contact your legal advisor. Under no circumstances will TEAC Corporation be responsible for the consequences of any illegal copying performed using the recorder.

---

## SD cards

---

This unit uses SD cards for recording and playback. You can use 64 MB–2 GB SD cards and 4 GB–32 GB SDHC cards with this unit.

A list of SD cards that have been tested with this unit can be found on the TASCAM web site (<http://tascam.com/>).

Use of cards that have not been verified for use with this unit could result in the unit not functioning properly.

---

## Precautions for use

---

SD cards are delicate media. In order to avoid damaging a card or the card slot, please take the following precautions when handling them.

- Do not leave in extremely hot or cold places.
- Do not leave them in extremely humid places.
- Do not let them get wet.
- Do not put things on top of them or twist them.
- Do not hit them.
- Do not remove or insert an SD card during recording, playback, data transfer or other operation that accesses the card.

---

## Precautions for placement and use

---

- The operating temperature should be between 0°C and 40°C (32°F and 104°F).
- Do not install in the following types of places. Doing so could degrade the sound quality and/or cause malfunctions.
  - Places with significant vibrations or that are otherwise unstable
  - Near windows or other places exposed to direct sunlight
  - Near heaters or other extremely hot places
  - Extremely cold places
  - Places with bad ventilation or high humidity
  - Very dusty locations
  - Places that could be directly exposed to rain or other water
- Hum might occur if a powered amplifier or other device with a large transformer is used near this unit. If this should happen, try increasing the distance between this unit and that device and changing their orientations.
- Uneven colors might appear on televisions and noise might be heard from radios that are used near this unit. If this should happen, use the unit further from the affected device.
- Noise might be heard from this unit if a mobile telephone or other wireless device is used nearby during calls and when data is transmitted and received. If this should happen, use that device farther from the unit or turn its power off.

- In order to promote the emission of heat, do not place anything on top of this product.
- Avoid installing this unit on top of any heat-generating electrical device such as a power amplifier.

---

## Beware of condensation

---

If the unit is moved from a cold to a warm place, or used after a sudden temperature change, there is a danger of condensation; vapor in the air could condense on the internal mechanism, making correct operation impossible. To prevent this, or if this occurs, let the unit sit for one or two hours at the new room temperature before using.

---

## Cleaning the unit

---

To clean the unit, wipe gently with a soft dry cloth. Do not use any benzene, paint thinner, ethyl alcohol or other chemical agents to clean the unit as they could damage the surface or cause fading.

---

## User registration

---

See the end of this manual for details about user registration.

# 2 – Names and Functions of Parts

## Top pane

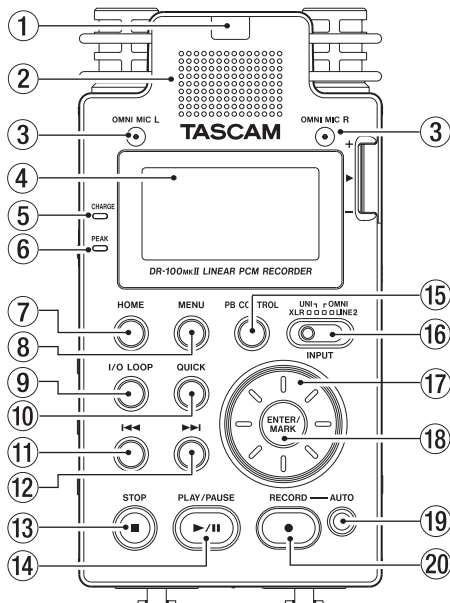

- ① **Remote sensor**  
Receives signals from the included remote control (RC-10). When using the remote point it here. (See “Wireless use” on page 22.)
- ② **Mono speaker**  
Use this built-in speaker to listen to recordings. The speaker will not produce sound in the following situations.
  - When in recording standby
  - When headphones are connected
  - When recording
  - When the speaker output setting is off
  - When in overdubbing mode
- ③ **Omnidirectional stereo mic pair (OMNI MIC L/R)**  
Two built-in electret condenser mics allow recording in stereo.
- ④ **Display**  
Shows a variety of information.
- ⑤ **CHARGE indicator**  
Lights when the lithium ion battery is being charged and turns off when charging completes.
- ⑥ **PEAK indicator**  
Lights red just before the recording volume level becomes so high that distortion would occur.
- ⑦ **HOME button**  
Press this button when one of the setting screens is open to return to the Home Screen. When the Home Screen is open, press this to switch between displaying elapsed and remaining time.

- ⑧ **MENU button**  
Press to open the MENU Screen when the Home Screen is open.  
When the Home Screen is open, press and hold this button to switch the backlight setting between ALWAYS (always lit) and OFF (always unlit).  
When one of the various settings screens is open, press this button to return to the MENU screen.
- ⑨ **I/O LOOP button**  
Press to set the starting (IN) and ending (OUT) points to define the desired interval for loop playback. When starting (IN) and ending (OUT) points have already been set, pressing this button will clear those points. (See “Loop playback” on page 45.)
- ⑩ **QUICK button**  
When the Home Screen is open and the recorder is stopped, paused or playing back, press this button to open the QUICK popup menu. See “Add identification tags to files (QUICK TAG)” on page 40 and “Delete the selected file (QUICK DEL)” on page 41.
- ⑪ **◀◀ button**  
Press this button to return to the beginning of a playback file that is playing or stopped in the middle. If you press this button when a file is stopped at its beginning, the unit will skip to the beginning of the previous file.  
Press and hold this button to search backwards.  
Press this button while pressing and holding the **ENTER/MARK** button to return to the previous mark.  
On the setting screens, use this button to move the cursor left.  
On the BROWSE Screen, press this button to move up a level.
- ⑫ **▶▶ button**  
Press this button during playback or when playback is stopped to skip to the beginning of the next file.  
Press and hold this button to search forward.  
On the setting screens, use this button to move the cursor right.  
Press this button while pressing and holding the **ENTER/MARK** button to move to the next mark.  
On the BROWSE Screen, press this button to move down a level. If a file is selected, the file is loaded and the unit returns to the Home Screen and stops.  
Press during recording to start a new track and continue recording without pause.
- ⑬ **STOP [■] button**  
During playback, press this button to pause playback at the current position. When paused, press this button to return to the beginning of the playback file.  
Press this button during recording or recording standby to cause the recording to stop.  
Use this button to answer “NO” to a confirmation message.

## 2 – Names and Functions of Parts

### ⑭ **PLAY/PAUSE [▶/||] button**

When the Home Screen is displayed and playback is stopped, press this button to start playback.

During playback, press this button to pause.

When a file or folder is selected in the **BROWSE** screen, press this button to return to the Home Screen and play the file or the first file in the folder from the beginning.

### ⑮ **PB CONTROL button**

Use to open and close the **PB CONTROL** screen and to turn its functions ON and OFF. (See “Special playback control functions” on page 45.)

### ⑯ **INPUT switch**

Set to the desired input signal source.

### ⑰ **Wheel**

Use this to select items and change values on setting screens.

Use it also to change the playback position in a track.

### ⑱ **ENTER/MARK button**

Use this to confirm the selection of a setting item or to answer “YES” to a confirmation message.

During recording or playback, press this button to add a mark manually.

While pressing this button, press the **STOP [■]** button to clear the nearest mark earlier in the file.

Press the **◀◀** or **▶▶** button while pressing and holding this button to move to the previous or next mark, respectively. (See “Mark function” on page 36.)

### ⑲ **AUTO button**

Use this to make various settings for the automatic recording function and to enable it. (See “Automatic recording (AUTO REC)” on page 35.)

### ⑳ **RECORD [●] button/indicator**

Press this button when stopped to start recording standby. The recording indicator will blink when in standby.

Press this button when in recording standby to start recording. The recording indicator will light when recording.

Press this button when recording to pause recording.

## Front panel

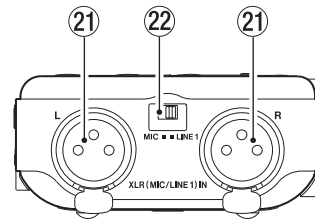

### ⑳ **XLR (MIC/LINE 1) IN L/R connectors**

These are balanced XLR connectors for analog inputs.  
(1: GND, 2: HOT, 3: COLD)

#### **CAUTION**

- Confirm that phantom power is OFF before connecting a line level device to a XLR (MIC/LINE 1) IN connector. If you connect a line level device while phantom power is being supplied, that device and this unit could be damaged.
  - When using a condenser microphone, before connecting to and disconnecting from a **XLR (MIC/LINE 1) IN** connector, confirm that the phantom power for that connector is OFF. If you connect or disconnect a mic while phantom power is being supplied, that mic and this unit could be damaged.
  - Do not connect an unbalanced dynamic mic to an XLR connector when phantom power is being supplied. Doing so could damage that mic and this unit.
- ⑳ **MIC/LINE 1 switch**  
Use this to set the input type of the **XLR (MIC/LINE 1) IN** connector.

## Rear panel

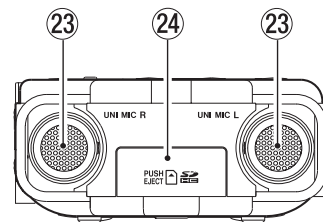

### ㉓ **Directional stereo mic pair (UNI MIC L/R)**

These are built-in electret condenser stereo mics.

### ㉔ **SD card slot**

Insert and remove SD cards.

## 2 – Names and Functions of Parts

### Left side panel

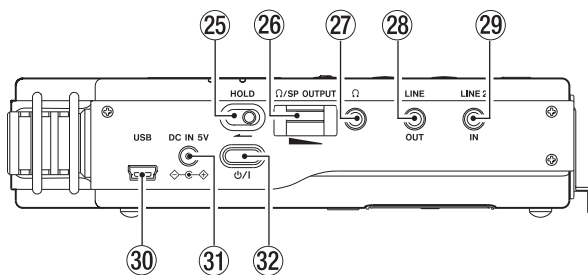

- ②5 **HOLD switch**  
Shift to the left end (in the direction of the arrow) to engage the hold function.  
All buttons are inoperative when hold is ON.
- ②6 **Ω/SP OUTPUT volume control**  
Use to adjust the volume output from the built in speaker or Ω jack.
- ②7 **Ω jack**  
Use to connect headphones. (See “Connecting monitors and headphones” on page 25.)
- ②8 **LINE OUT jack**  
Use a stereo mini jack cable to connect to the line input connector on an external device.
- ②9 **LINE 2 IN jack**  
Use a stereo mini jack cable to connect to the line output connector on audio equipment or other external device.
- ③0 **USB port**  
Connect to a computer using the included USB cable. (See “7 – Connecting with a Computer” on page 47.)

#### NOTE

Always connect the recorder directly to a computer. Do not use a USB hub.

- ③1 **DC IN 5V connector**  
Connect a PS-P520 AC adaptor or BP-6AA battery pack (both sold separately).
- ③2 **⏻ / I button**  
Press and hold to turn the power ON and OFF.

### Right side panel

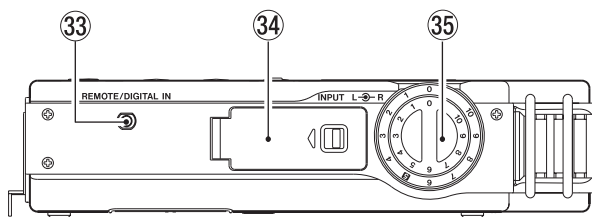

- ③3 **REMOTE/DIGITAL IN jack**  
Connect the included TASCAM RC-10 wired remote control or a TASCAM RC-3F footswitch (sold separately) here. You can use the remote control to operate the unit, including stopping and starting playback. (See “9 – Using the REMOTE/DIGITAL IN jack” on page 52.) In addition, you can input a digital signal by connecting the included digital input conversion cable. (See “Using digital input” on page 52.)
- ③4 **Battery compartment (specialized lithium ion battery)**  
Compartment for the unit’s dedicated lithium ion battery. (See “Using the lithium ion battery” on page 20.)
- ③5 **INPUT knob**  
Adjusts the input volume.

### Bottom panel

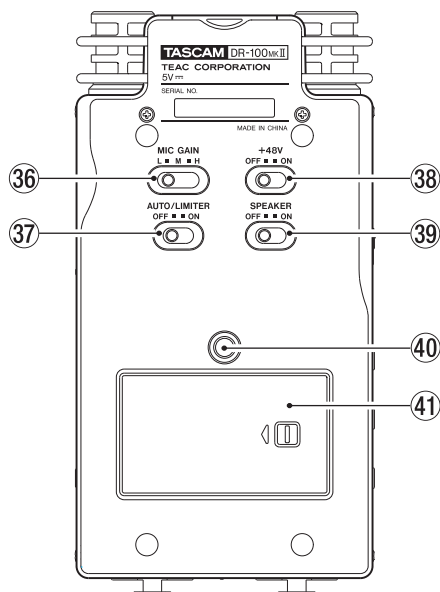

- ③6 **MIC GAIN switch**  
Set the sensitivity of the mic input.

## 2 – Names and Functions of Parts

### 37 AUTO/LIMITER switch

Set this to **ON** to activate the automatic gain control or limiter. (See “Using the level control function” on page 32.)

### 38 +48V (phantom power) switch

Turn this **ON** to provide +48 V of power when a condenser mic is connected to the **XLR (MIC/LINE 1) IN L/R** connector.

#### CAUTION

Do not connect or disconnect mics when the +48V switch is ON.

### 39 SPEAKER switch

Set this to **ON** to output sound from the built-in speaker.

#### NOTE

Even when ON, no sound is output during recording, in recording standby or when headphones are connected.

### 40 Tripod attachment screw hole (1/4-inch)

Use this to attach the unit to a tripod or mic stand.

#### CAUTION

- Tighten the unit securely to the tripod or mic stand to prevent it from falling off.
- Place the tripod or mic stand on a level surface when using it with this unit.
- Some tripods use different types of screws, so it might not be possible to attach the unit directly. In such a case, purchase and use a suitable adapter.
- Screws longer than 4.5 mm cannot be used with this.

### 41 Battery compartment cover

### 42 AA battery compartment

This compartment can hold two AA batteries that can power the unit. (See “Using AA batteries” on page 20.)

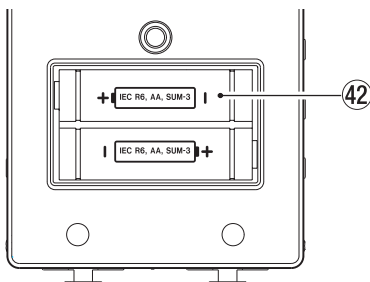

## Remote control (TASCAM RC-10)

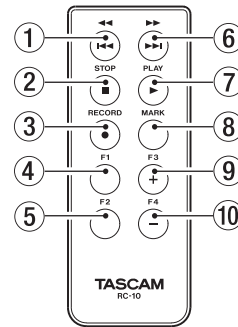

### 1 ◀◀/|◀ button

Press this button briefly to return to the start of a file. If the playback position is already near the start of a track, it will skip to the start of the previous file. Press and hold this to search a track in reverse.

### 2 STOP [■] button

Press to stop playback and recording.

### 3 RECORD [●] button

Use to start recording standby and recording, as well as to pause recording.

### 4 F1 button

Use this with the automatic recording function. Unlike the button on the main unit, this button alone can put the unit into recording standby.

#### NOTE

Use the main unit to make various AUTO REC function settings.

### 5 F2 button

Use to set the low-cut filter. Each time you press this button, the setting value changes as shown below. (See “Making analog input settings” on page 30.)

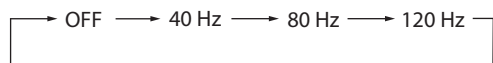

### 6 ▶▶/▶▶| button

Press this button briefly to move to the start of the next file. Press and hold this to search a track forward.

### 7 PLAY [▶] button

Press to start playback.

### 8 MARK button

Press during recording or playback to add a mark manually.

### 9 F3 button

This has the same function as the **I/O LOOP** button on the recorder. (See “Loop playback” on page 45.)

### 10 F4 button

Use to switch the backlight setting between **ALWAYS** (always lit) and **OFF** (always unlit). (See “Automatic backlight OFF setting” on page 49.)



## 2 – Names and Functions of Parts

### Home screen

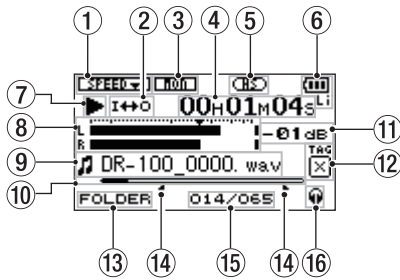

#### ① Playback speed setting

Depending on the current playback speed setting, one of the following icons appears.

On	Off	Playback speed
		0%
		+1% - +16%
		-50% - -1%
		Playback speed cannot be changed

#### ② Loop/repeat playback setting

Depending on the status, one of the following icons appears.

	Single playback
	Single track repeat playback
	All track repeat playback
	Loop playback

#### ③ Monitor mix status

This icon shows whether the monitor mix is ON or OFF. (See “Monitoring input signals” on page 34.)

	Monitor mix OFF
	Monitor mix ON

#### ④ Elapsed time/remaining time

This shows the elapsed or remaining time (hours: minutes: seconds) of the file being played back. When the Home Screen is open, press the **HOME** button to switch between showing the elapsed time and the remaining time. A “-” appears at the start of the remaining time.

#### ⑤ Operation mode indicator

This icon shows the operation mode. (See “Mode selection” on page 25.)

	When set to STD mode
	When set to HS mode

#### ⑥ Power supply status

The following icons appear according to the power supply status.

	Lithium ion battery (TASCAM BP-L2)
	AA batteries
	AC Adaptor

When batteries are used, the amount of power remaining is shown as: .

When battery power is depleted the empty battery icon blinks. The power soon turns OFF automatically. The indicator appears when a TASCAM PS-P520 AC adaptor (sold separately) or TASCAM BP-6AA external battery pack (sold separately) is connected.

#### NOTE

Sometimes a Battery Low warning appears when recording or conducting other demanding operations even when battery power remains.

#### ⑦ Recorder operation status

This icon shows the recorder operation status.

Display	Operation
	Stopped
	Paused
	Playing back
	Fast-forwarding
	Fast-rewinding
	Skip to the beginning of the next file
	Skip to the beginning of the current file or the previous file

#### ⑧ Level meters

These show the levels of the input or playback signals. When monitor mix is ON, the levels of the combined input and playback sounds are shown.

#### ⑨ File information

The file name or tag information of the file currently being played back is shown. ID3 tag information is shown when available for an MP3 file being played.

#### NOTE

ID3 tag information includes the titles and artists names that can be saved in MP3 files.

#### ⑩ Playback position display

The current playback position is shown by a bar. As playback progresses, the bar extends to the right.

#### ⑪ Peak value in decibels (dB)

The maximum level that occurs in a fixed period of time is displayed digitally.

#### ⑫ Identification tag





If an identification tag has been added using the QUICK TAG function, it will appear here.

#### ⑬ Playback range

This shows the current playback area.

ALL	All files in the MUSIC folder
FOLDER	All files in the selected folder
P.LIST	All files added to the playlist



## 2 – Names and Functions of Parts

- ⑭ **Loop playback IN (starting) and OUT (ending) points**  
The settings of loop playback starting (IN) and ending (OUT) points are shown. When the starting (IN) point is set, the  icon appears below the corresponding position on the playback position bar. When the ending (OUT) point is set, the  icon appears below the corresponding position on the playback position bar.
- ⑮ **Playback file number/total number of files**  
The total number of files in the playback area and the number of the current file are shown.
- ⑯ **Monitoring output**  
Depending on the status, one of the following icons appears.
-  Sound output from the headphone jack
  -  Sound output from the speaker

time available on the SD card is less, however, that will be shown instead.

When in recording standby or recording, press the **HOME** button to switch between the elapsed recording time and the remaining recording time. When the remaining recording time is shown, a “-” appears before it.





- ⑥ **Recorder operation status**  
This icon shows the recorder operation status.

Icon	Meaning
	Recording standby
	Recording paused
	Currently recording

- ⑦ **Level meters**  
These show the levels of the input signals. When overdubbing is on, the levels of the combined input and playback signals are shown. On the scale, the  mark indicates a level of -16 dB to help you adjust the analog input level.

- ⑧ **File name**  
This shows the file name that will automatically be given to the file being recorded.

- ⑨ **Input signal setting**  
This icon shows the signal being input.

-  **XLR** XLR (MIC/LINE 1) IN L/R
-  **UNI** UNI MIC L/R (directional)
-  **OMNI** OMNI MIC L/R (omnidirectional)
-  **LINE** LINE 2 IN L/R









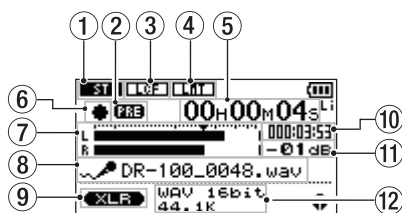

- ⑩ **SD card remaining recording time**  
This shows the remaining recording time (hours: minutes: seconds) on the SD card in the recorder.

- ⑪ **Peak value in decibels (dB)**  
The peak recording level is shown in decibels.

- ⑫ **Recording file type/bit length/sampling frequency**  
This shows the format, bit length and sampling frequency of the file being recorded.

### Recording screen



- ① **Stereo/mono setting**  
When recording with mics, this icon shows whether recording is in stereo or mono.
-  Stereo
  -  Mono
- ② **Prerecording setting**  
The **PRE** icon appears when the prerecording function is “ON” and the unit is in recording standby.
- ③ **Low-cut filter ON/OFF setting**  
This icon shows whether the low-cut filter is ON or OFF. When set to 40Hz, 80Hz or 120Hz, the icon appears as light letters on a dark background.
-  OFF
  -  40 Hz low-cut filter ON
  -  80 Hz low-cut filter ON
  -  120 Hz low-cut filter ON
- ④ **Auto gain control/limiter setting**
-  Auto gain control OFF
  -  Auto gain control ON
  -  Limiter OFF
  -  Limiter ON
- ⑤ **Elapsed/remaining recording time**  
This shows the elapsed time of the file being recorded or the remaining time (hours: minutes: seconds) according to the set maximum file size. If the remaining

## 2 – Names and Functions of Parts

### Menu item list

Press the **MENU** button to open the **MENU** screen. The menu items are as shown below.

Menu item	Function	Pages
INFORMATION	Information about the file, SD card, and system	48
BROWSE	SD card file and folder operations	39
PLAYLIST	Edit the playlist	43
PLAY MODE	Make playback area and repeat playback settings	42, 45
INPUT SETTING	Make analog input settings	30, 32, 34
REC SETTING	Make recording settings	27, 37
MIX BALANCE	Adjust input and playback sound levels	34
DIVIDE	Divide files	33
FILE NAME	Make file name settings	51
REMOTE/DIGI IN	Make settings for TASCAM RC-3F footswitch (sold separately), TASCAM RC-10 wired remote control (included) and digital input, and select the active one	52
SETUP	Make various settings	49
BATTERY	Make settings related to the battery	50
DATE/TIME	Make date and time settings	23

### Using menus

In this example, we show how to change the sampling frequency.

- 1 Press the **MENU** button to open the **MENU** screen.



- 2 Use the wheel to select a menu item (highlighted), and press the **ENTER/MARK** button to move to various settings screen.



REC SETTING selected

- 3 Use the wheel to select a menu item (highlighted) to be set.

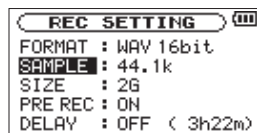

REC SETTING screen

- 4 Press the **▶▶** or **ENTER/MARK** button to move the cursor to highlight the value of the setting.

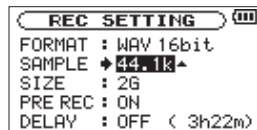

- 5 Use the wheel to change the setting.
- 6 To set a different item in the same menu, press the **◀◀** button.  
This enables you to select a new item. Use the wheel again to select an item to be set.
- 7 Repeat step 3 to 6 as necessary to set each item.
- 8 To open the **MENU** screen, press the **MENU** button.  
To return to the Home Screen, press the **HOME** button.

---

### Basic operation

---

Use the following buttons to operate the various screens.

#### **MENU button**

Opens the MENU screen.

#### **PB CONTROL button**

Opens the PB CONTROL screen.

#### **AUTO button**

Opens the AUTO REC screen.

#### **HOME button**

When any other screen is open, press this to return to the Home Screen.

#### **ENTER/MARK button**

Use this to confirm the selection of a setting item or to answer "YES" to a confirmation message.

#### **STOP button**

Use this to answer "NO" to a confirmation message.

#### **▶▶ button**

Use this to move the cursor (the highlighted area) to the right on the screen, and to open folders on the BROWSE screen.

#### **◀◀ button**

Use this to move the cursor (the highlighted area) to the left on the screen, and to close folders on the BROWSE screen.

#### **Wheel**

Use to select (highlight) items and change values.

#### **QUICK button**

Use to open the QUICK popup menu on the Home Screen.

# 3 – Preparation for Use

## Preparing the power

### Power source options

This recorder can be powered by the included TASCAM BP-L2 lithium-ion rechargeable battery, two AA batteries, a TASCAM PS-P520 AC adaptor (sold separately) or a TASCAM BP-6AA external battery pack (sold separately). By using both the lithium-ion rechargeable battery and AA batteries together, the unit can be operated continuously for a long time. Moreover, when, for example, the charge becomes low in one type of battery, batteries can be changed while the unit continues to operate. Alkaline and nickel-metal hydride AA batteries can be used with this recorder.

#### NOTE

- Manganese dry cell batteries (R6) cannot be used with this unit.
- This unit cannot recharge Ni-MH batteries. Use a commercially available recharger.

### Using the lithium ion battery

Open the battery compartment cover on the side of the unit, insert the battery with the correct orientation into the compartment, and then close the cover again.

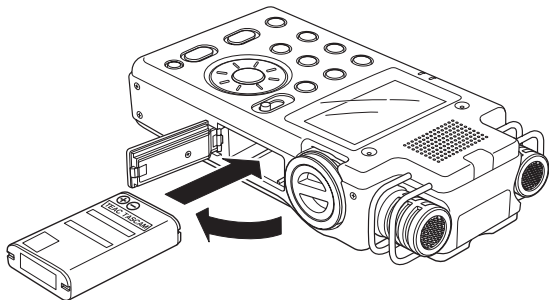

### Charging the lithium ion battery

There are two ways to charge the lithium ion battery.

#### Charging with an AC adaptor

Connect a TASCAM PS-P520 AC adaptor (sold separately) to the unit's **DC IN 5V** connector. Charging takes about three hours. (See "Using an AC adaptor (sold separately)" on page 21.)

#### Charging with a computer

Connect with a computer using the included USB cable. Charging takes about six hours. (See "7 – Connecting with a Computer" on page 47.)

#### NOTE

- Connect this unit to the computer directly. Proper operation cannot be guaranteed when using a USB hub.
- When connected by USB, recharging occurs even if the unit's power is off.

- When recharging through the USB port, the unit will switch to USB connection mode, so other functions cannot be used.
- The **CHARGE** indicator lights while charging and turns off when charging is complete.

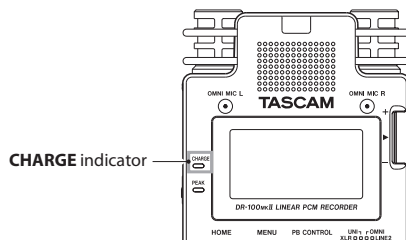

### Using AA batteries

Open the battery compartment cover on the back of the unit, install the two batteries with the correct +/- orientation and close the battery compartment cover.

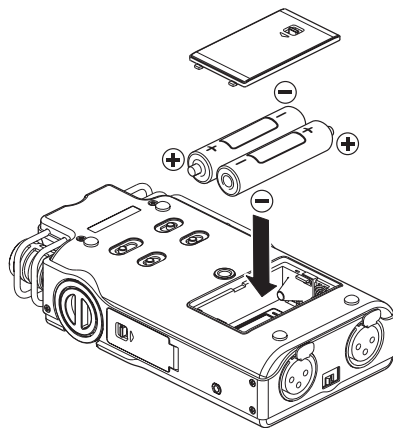

When using AA batteries, set the type of battery in order to accurately show the amount of power remaining and allow the unit to accurately determine whether power is available for proper operation. (See "Setting the type of AA batteries (AA BATTERY)" on page 51.)

### Using both types of batteries together

If you install both the lithium ion battery and AA batteries, you can set one as the main power source and the other as the backup. (See "Setting the main battery source (MAIN)" on page 50.) By doing this, when the amount of power left in the main source becomes insufficient for operation, the unit automatically switches to the backup source, allowing continued operation. Moreover, you can change the backup while operating using the main power source. This allows you to continue to use the unit for long periods of time. (See "Changing batteries when the power is on" on page 50.)

## 3 – Preparation for Use

### Using an AC adaptor (sold separately)

Connect the TASCAM PS-P520 AC adaptor (sold separately) to the **DC IN 5V** connector as shown in the illustration.

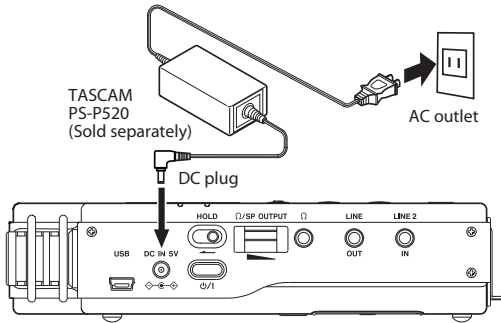

#### CAUTION

Never use any adaptor other than the designated PS-P520 AC adaptor. Use of a different adaptor could cause malfunction, fire or electric shock.

#### NOTE

- Noise may occur when recording with a microphone if the unit is too close to the AC adaptor. In such a case, keep sufficient distance between the AC adaptor and the unit.
- The AC adaptor provides power when connected even if batteries are installed.
- If installed, the lithium ion battery can also be recharged while the unit is used.

### Using an external battery pack (sold separately)

Connect a TASCAM BP-6AA external battery pack (sold separately) to the **DC IN 5V** jack, as shown in the illustration.

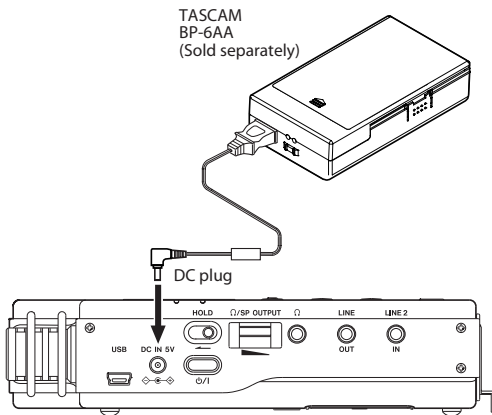

#### CAUTION

Never use any external battery pack other than the TASCAM BP-6AA. Use of a different battery pack could cause malfunction, fire or electric shock.

#### NOTE

If you connect a TASCAM BP-6AA external battery pack via the included cord to this recorder while the recorder still has batteries in it, power will be provided by the external battery pack.

## Preparing the remote control

### Installing the battery

- 1 Remove the battery holder. While pressing ①, pull in direction ②.

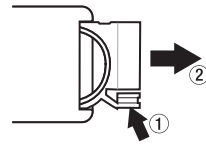

- 2 Install the coin-shaped lithium ion battery (CR2025) into the holder with the correct +/- orientation.

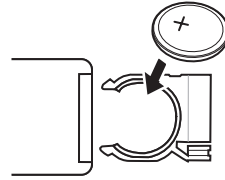

- 3 Reinsert the battery holder into the remote control.

#### NOTE

At the time of purchase, this remote control comes with a lithium coin battery (CR2025) installed. Before using the remote control, pull the isolation sheet out of the battery compartment.

### When to change the battery

Replace the battery with a new one when the range of the remote control becomes short or if the function buttons become unresponsive.

Use a coin-shaped lithium ion battery (CR2025).

### Cautions about the use of the battery

Accidental swallowing of batteries by small children is extremely dangerous. Keep batteries and remote controls out of reach of small children. Consult a physician immediately if a child should swallow a battery.

Misuse of a battery could cause it to leak, rupture or otherwise be damaged. Please read and abide by the following precautions when using batteries. (Also see "Cautions about batteries" on page 4.)

- Install the battery with the correct orientation.
- Do not recharge the battery.
- Do not heat or disassemble the battery or put it into fire or water.

## 3 – Preparation for Use

- Do not carry or store the battery with small metal objects. Doing so could short the battery and cause leakage or rupture, for example.
- When storing or disposing of the battery, cover the contacts with tape to prevent them from touching other batteries or metal objects.
- Follow the disposal instructions written on the battery or provided by the local government when you are done using it.

### Using the remote control (TASCAM RC-10)

#### Wireless use

Point the remote control at the remote control receiver on the unit.

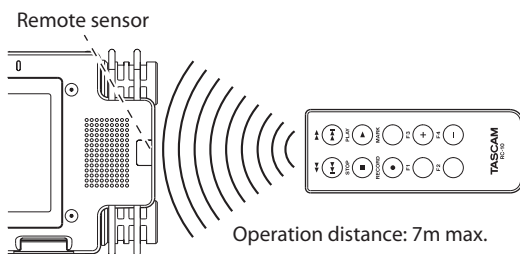

#### NOTE

- The operation distance varies depending on the angle.
- If anything is between the remote control and the sensor, operation might not work.

#### Wired use

Attach the wired remote control adapter and cable.

- 1 Insert the wireless remote control into the wired remote control adapter.

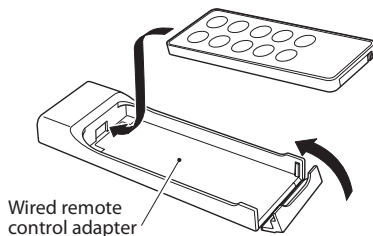

- 2 Connect the cable to the wired remote control adapter.

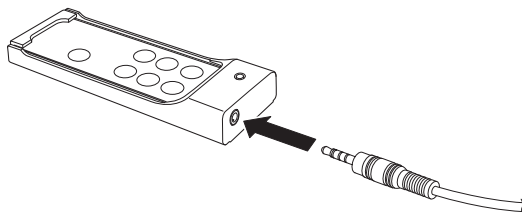

- 3 Connect the cable to the REMOTE/DIGITAL IN jack on the right side of the recorder.

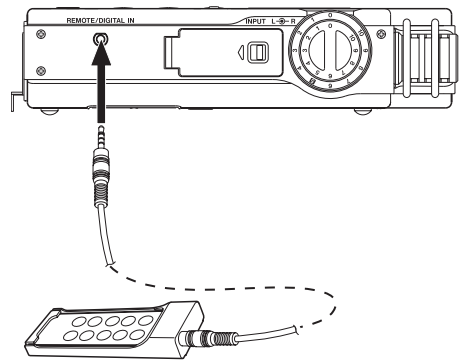

#### Enable wired remote control use

On the REMOTE/DIGI IN setting screen, enable use of the wired remote control.

- 1 Press the MENU button to open the MENU screen.
- 2 Use the wheel to select REMOTE/DIGI IN and press the ENTER/MARK button to open the REMOTE/DIGI IN setting screen.
- 3 Use the wheel to select FUNCTION, and press the ENTER/MARK or ►► button.
- 4 Use the wheel to set FUNCTION to RC-10 (default value: RC-10).

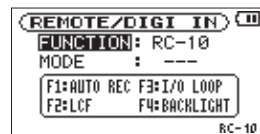

- 5 After completing the setting, press the HOME button to return to the Home Screen.

#### Precautions for use of the remote control

- Remove the battery when you are not using the remote control for a long time (one month or more).
- If the battery should leak, thoroughly clean any residue from inside the battery compartment and install a new battery.
- When using other devices controlled by infrared rays, use of this remote control might operate these devices by mistake.
- Using a cable other than the one included could damage the remote control and the unit being controlled.
- The wired remote control will only function if FUNCTION is set to RC-10 on the REMOTE/DIGI IN screen. (See "Enable wired remote control use" above.)



## Turning the power on and off

### CAUTION

- Turn down the volume of the sound system connected to the unit before starting up or shutting down the unit.
- Do not use headphones when starting up or shutting down the unit. Otherwise, a large noise would cause damage to headphones or your ears.

## Starting up the unit

To start up the unit from the stopped state, press and hold the  $\phi / |$  button until TASCAM DR-100MKII (start-up screen) is displayed on the display.

The Home Screen appears when the unit starts up.



Start-up screen

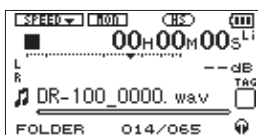

Home screen

### CAUTION

When the unit is started up for the first time (or when the built-in clock is reset after being left unused without batteries), the DATE/TIME screen appears before the start-up screen to adjust the date and time. (See “Setting the date and time” on page 23.)



## Shutting down

Press and hold the  $\phi / |$  button until LINEAR PCM RECORDER appears on the display.

The power turns off after the unit completes its shutdown process.



### CAUTION

Always use the  $\phi / |$  button to turn the unit power OFF. When the power is ON, do not remove the battery (or batteries) set as the MAIN battery or disconnect the PS-P520 adaptor (sold separately) if no batteries are installed. Doing so will cause all recordings, settings and other data to be lost. Lost data cannot be restored.

## Battery settings

You can set either the lithium ion battery or the AA batteries as the main power source and the other as the backup source when both are installed. (See “Setting the main battery source (MAIN)” on page 50.)

By doing this, when the amount of power left in the main source becomes insufficient for operation, the unit automatically switches to the backup source, allowing continued operation.

Moreover, when using AA batteries, the battery type must be set in order for the unit to display remaining time and operate correctly. (See “Setting the type of AA batteries (AA BATTERY)” on page 51.)

## Setting the date and time

Using its internal clock, this unit remembers the date and time when a file is recorded.

- 1 Press the MENU button to open the MENU screen.



- 2 Use the wheel to select the DATE/TIME menu item (highlighted), and press the ENTER/MARK button.



The DATE/TIME screen is displayed.

## 3 – Preparation for Use

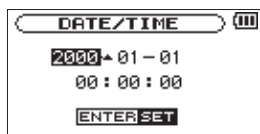

- 3 Press the **◀◀** or **▶▶** button to move the cursor (highlighted area), and use the wheel to change values.
- 4 Press the **ENTER/MARK** button to confirm the change and return to the **MENU** screen.

### NOTE

- While setting the time, the time display stops changing.
- You can set the unit to automatically add the date to file names. (See “Setting the format of file names” on page 51.)

### CAUTION

The date and time setting can only be maintained for a few minutes if the unit is not powered from batteries or through the TASCAM PS-P520 AC adaptor (sold separately). When using batteries, replace them before they completely lose power.

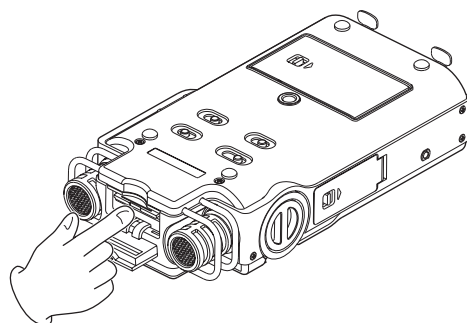

### CAUTION

- Do not remove the SD card from the unit when it is connected to a computer by USB.

### NOTE

- SD cards that meet SD or SDHC standards can be used with this unit.
- A list of SD cards that have been confirmed to work with this unit can be found on our website (<http://tascam.com/>).

## Inserting and removing SD cards

### Inserting the card

#### NOTE

An SD card is already installed when the unit is shipped from the factory. If you want to use this card to record and play tracks, there is no need to reinstall it.

- 1 **Open the SD slot cover on the rear panel.**
- 2 **Insert the SD Card into the slot as shown in the following illustration until it clicks into place.**

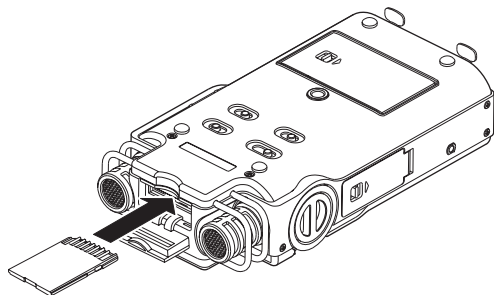

### Removing the card

- 1 **Open the SD slot cover.**
- 2 **Press the SD card in gently and then release it to allow it to come out.**

### SD card write protection

SD cards have protect switches that prevent writing new data to them.

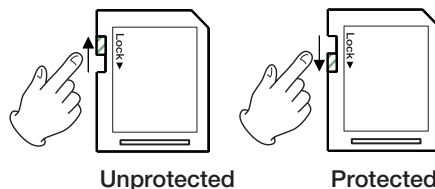

If you slide the protect switch to the “LOCK” position, file recording and editing is not possible. Move the switch to the unlocked position in order to record, erase and otherwise edit data on the card.

### Preparing an SD card for use

In order to use an SD card in this unit, you must format it first.

#### CAUTION

- Please use a PS-P520 AC adaptor (sold separately) or make certain that there is sufficient remaining battery power when formatting a card.
- Formatting a card erases all the data on it.

- 1 **Confirm that an SD card is installed and turn the power ON.**
- 2 **The following message appears when a new card or a card formatted for use with another device is installed in the unit.**

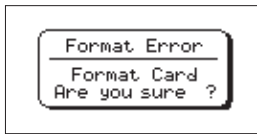

- 3 Press the ENTER/MARK button to start formatting.
- 4 When formatting ends, the Home Screen opens.  
You can also reformat the card in this unit at any time. (See “Using QUICK FORMAT” on page 50 and “Using FULL FORMAT” on page 50.)

## Mode selection

You can set the operation mode used for recording and playback.

### Setting the mode

- 1 While pressing the ENTER/MARK button press the **⏻** / **|** button to turn the power ON and open the MODE SELECT screen.

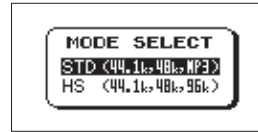

#### STD (default)

Standard mode for using WAV files with sampling frequencies of 44.1 or 48 kHz and MP3 files

#### HS

Mode for using WAV files with sampling frequencies of 44.1, 48 or 96 kHz

- 2 Use the wheel to select the mode to use, and press the ENTER/MARK button to confirm the setting. The unit will start in the selected mode.

#### NOTE

The selected mode setting is retained and will be used the next time the unit power is turned ON.

### Confirming the mode

You can confirm the set mode by checking the icon on the Home Screen. When set to STD mode the **STD** icon appears, and when set to HS mode, the **HS** icon appears.

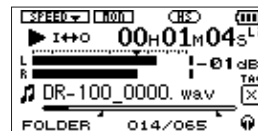

Home Screen when set to STD mode

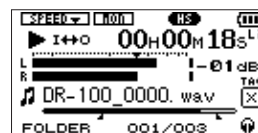

Home Screen when set to HS mode

When set to HS mode, HS MODE appears in a popup when the unit is started up.



## Using the built-in speaker

Set the **SPEAKER** switch on the bottom panel to **ON** to listen to a playing track through the built-in speaker.

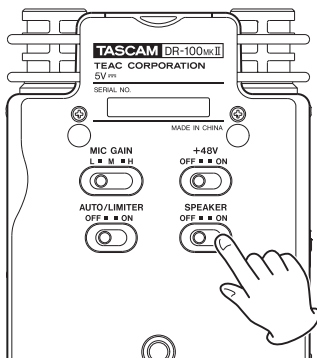

#### NOTE

Even when ON, no sound is output during recording, in recording standby or when headphones are connected.

## Connecting monitors and headphones

To listen with headphones, connect them to the **Ⓜ** connector on the left side panel.

To listen with an external monitoring system (powered monitor speakers or amplifier and speakers), connect it to the **LINE OUT** connector on the left side panel.

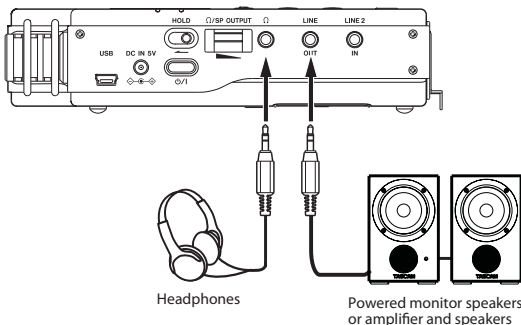

## 3 – Preparation for Use

### Restrictions when using HS mode

HS mode has the following limitations.

- You cannot record or play back MP3 files. Use STD mode to work with MP3 files.
- 96 kHz WAV files cannot be overdubbed.
- Playback speed adjustment and VSA functions cannot be used with 96 kHz WAV files. The SPEED icon on the Home Screen appears with an "X" in it to show this.

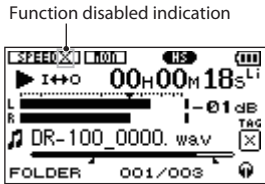

- When using loop playback with 96 kHz WAV files, a gap will occur at the beginning of the loop.
- When starting a new track and continuing recording without pause using 96 kHz WAV files, each recorded file must be at least 4 seconds long.

# 4 – Recording

In addition to recording with the built-in stereo mics, this unit can also record signals from external mics and connected audio equipment, including CD players. The recording audio file format can be set to MP3 (32–320 kbps, 44.1/48 kHz) or WAV (44.1/48/96 kHz, 16/24-bit). Moreover, when an audio file is playing back, you can record the playback sound mixed together with the input sound to create a new file (overdubbing, excluding 96 kHz).

## Setting the mode

Set the operation mode to use when recording. (See “Mode selection” on page 25.) Depending on the operation mode, other setting options differ.

## Selecting file format, sampling frequency, and maximum file size

Select the audio file type that you want to record before you start recording.

- 1 Press the MENU button to open the MENU Screen.
- 2 Use the wheel to select REC SETTING menu item, and press the ENTER/MARK button.

REC SETTING screen appears.

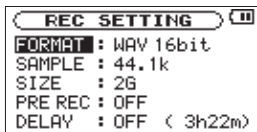

- 3 Use the wheel to select FORMAT item, and press the ►► or ENTER/MARK button.

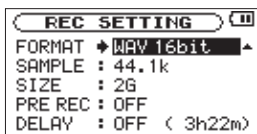

- 4 Set the file format. Use the wheel to select one of the following formats.

### STD mode setting options:

WAV 16bit (default value), WAV 24bit, MP3 32kbps, MP3 64kbps, MP3 96kbps, MP3 128kbps, MP3 192kbps, MP3 256kbps, MP3 320kbps

### HS mode setting options:

WAV 16bit (default), WAV 24bit

### NOTE

Higher values provide better recording quality. WAV files are higher quality than MP3 files, but they take up more space, so MP3 formats allow for longer recordings.

- 5 Press the ◀◀ button to show settings.
- 6 Use the wheel to select SAMPLE, and press the ►► or ENTER/MARK button.

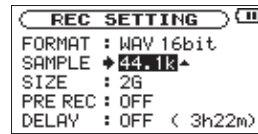

Set the sampling frequency with the wheel to one of the following options.

### STD mode options:

44.1k (default), 48k

### HS mode options:

44.1k (default), 48k, 96k

- 7 Press the ◀◀ button to show settings.

- 8 Use the wheel to select SIZE item, and press the ►► or ENTER/MARK button.

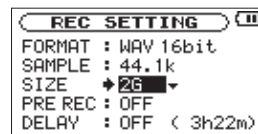

- 9 Set the maximum file size with the wheel to one of the following options.

64M, 128M, 256M, 512M, 1G, 2G (default)

### NOTE

- If the maximum set file size is exceeded during recording, the unit will automatically continue recording in a new file.
- Depending on the file format, the amount of recording time will differ for the same file size. The amount of recording time is shown on the right of the setting value (in parentheses)
- Recording automatically stops if recording time exceeds 24 hours.

- 10 After completing the setting, press the HOME button to return to the Home Screen.

## Available recording time display

The amount of time available for recording depends on the capacity of the SD card as well as the recording mode and sampling frequency settings. (See “Recording duration” on page 38.)

On the recording screen, you can check the amount of recording time possible on the SD card in the recorder.

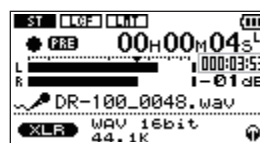

SD card  
Possible recording time

You can also check the possible recording time for the set file size on the REC SETTING screen. The possible recording time depends on the REC SETTING screen settings.

## 4 – Recording

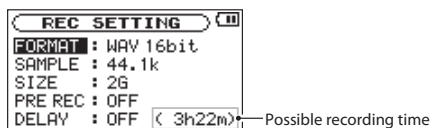

### Setting where files are saved

Set the folder where recorded files are saved. For details, see the SELECT popup menu items in “Folder operations” on page 40. If no setting is made, new recording files are placed in the MUSIC folder.

### Setting the analog input

Use the **INPUT** switch on the top panel to set the analog input source.

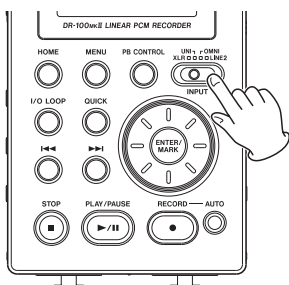

#### XLR

**XLR (MIC/LINE 1) IN** connectors on the front of the recorder

#### UNI

Built-in directional stereo mics

#### OMNI

Built-in omnidirectional stereo mics

#### LINE 2

**LINE 2 IN** jack on the left side of the recorder

#### NOTE

- The DR-100MKII has been designed with high gain to enable it to record even very quiet sounds. For this reason, if using an AC adaptor when the **MIC GAIN** is set to **H** (HIGH), touching the mics could cause noise (hum or modulation) to be heard depending on placement conditions. To avoid this, do not touch the built-in mics when recording with them. (See “Manually adjusting the analog input level” on page 31.)
- If **FUNCTION** is set to **DIGI IN** on the **REMOTE/DIGI IN** setting screen, moving the **INPUT** switch on the top panel will not change the input, and the following popup message will appear. (See “Using digital input” on page 52.)



You can also select the input of **XLR (MIC/LINE 1)** jack by changing the **MIC/LINE 1** switch on the front panel.

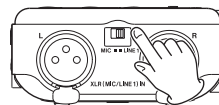

#### MIC

Use this setting when connecting external mics to the recorder.

#### LINE 1

Use this setting when connecting line output jacks of external devices to the analog inputs of this recorder.

### Recording with the built-in mics (UNI/OMNI)

#### UNI MICS

Set the **INPUT** switch on the top panel to **UNI**.

These mics are suitable for recording live performances of instrumentalists and bands, as well as field recording, for example.

Point the mics at the sound source and place the unit in a stable location where there is little vibration.

If noise is caused by wind, attach the windscreen.

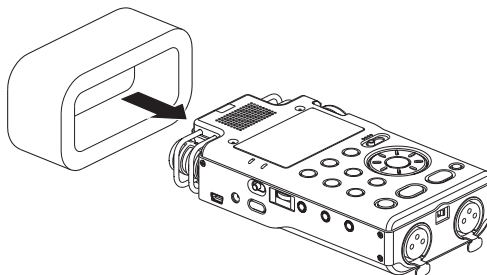

#### OMNI MICS

Set the **INPUT** switch on the top panel to **OMNI**.

These mics are suitable for recording meetings and other situations where you want to record everything in a wide space.

Place the unit in a stable location where there is little vibration.

#### NOTE

If noise is caused by air-conditioning or a draft, for example, use the unit's low-cut filter. (See “Making analog input setting” on page 30.)

### Recording with external mics (XLR)

Set the **INPUT** switch on the top panel to **XLR**, and **MIC/LINE 1** switch on the front panel to **MIC**.

Connect an external XLR mic to the **XLR (MIC/LINE 1) IN** connector.

When only one mic is connected, it is possible to record the same signal on both left and right channels. (See “Making analog input settings” on page 30.)

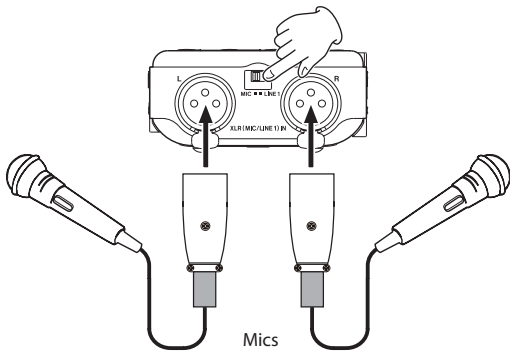

When using a condenser mic that requires phantom power, set the **+48V** switch on the bottom panel to **ON**.

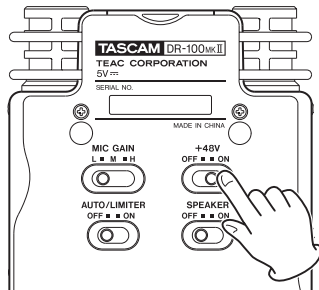

- Since using phantom power reduces the amount of time the unit can operate on battery power, we recommend that you use a TASCAM PS-P520AC adaptor (sold separately) or TASCAM BP-6AA external battery pack (sold separately).
- If alkaline batteries are used to supply phantom power, some microphones will only be able to be used for a very short amount of time. For this reason, we recommend that you use a TASCAM PS-P520AC adaptor (sold separately) or TASCAM BP-6AA external battery pack (sold separately).
- The amount of time that the unit can operate on battery power varies greatly according to the type of mic used. See the mic manual or documentation for additional information.

## Recording from external equipment (LINE 1)

Set the **INPUT** switch on the top panel to **XLR**, and set the **MIC/LINE 1** switch on the front panel to **LINE 1**.

Using an XLR stereo cable, you can connect the output of an external audio device to the **XLR (MIC/LINE 1) IN** connector on the front panel.

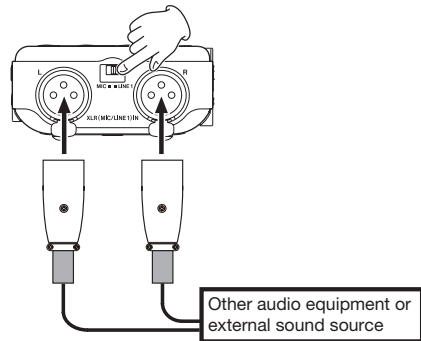

## Using phantom power

When the **+48V** switch on the bottom panel is set to **ON**, phantom power is turned on and sent to the connected mics.

### CAUTION

- Confirm that phantom power is OFF before connecting a line level device to a XLR (MIC/LINE 1) IN connector. If you connect a line level device while phantom power is being supplied, that device and this unit could be damaged.
- When using a condenser microphone, before connecting to and disconnecting from a **XLR (MIC/LINE 1) IN** connector, confirm that the phantom power for that connector is **OFF**. If you connect or disconnect a mic while phantom power is being supplied, that mic and this unit could be damaged.
- Do not supply phantom power to the **XLR (MIC/LINE 1) IN** connector when an unbalanced dynamic microphone is connected to it. Doing so could damage the mic or this recorder.
- Turn phantom power ON only when using a condenser microphone that requires phantom power.
- Supplying phantom power to some types of ribbon microphones could break them. Do not supply phantom power to a ribbon microphone if you are in doubt.
- Do not connect or disconnect the AC adaptor when using phantom power. Doing so could damage this device.

## Recording from external equipment (LINE 2)

Set the **INPUT** switch on the top panel to **LINE 2**.

Using a stereo miniplug cable, you can connect the output of an external audio device, including the headphone output of a portable CD player, for example, to the **LINE 2 IN** jack on the right side of the recorder.

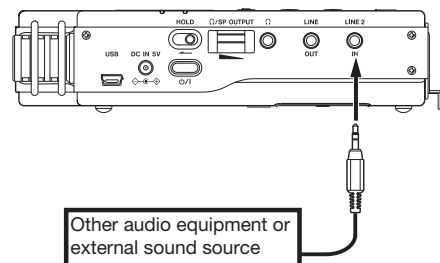



## 4 – Recording

### Setting the digital input

Using a digital audio cable, you can connect the output of digital audio equipment, such as a CD player's digital connector, using the included digital conversion cable to the **REMOTE/DIGITAL IN** jack on the left side panel.

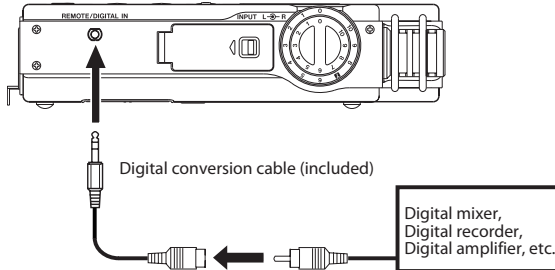

When the **FUNCTION** item is set to **DIGI IN** on the **REMOTE/DIGI IN** setting screen, you can record the digital output from external digital audio equipment. (See "Using digital input" on page 52.)

### Making analog input settings

You can make settings related to the various functions available when using mic inputs.

When you record a single external XLR mic, for example, you can record its signal to both the left and right channels.

- 1 Press the **MENU** button to open the **MENU** screen.
- 2 Use the wheel to select the **INPUT SETTING** menu, and press the **ENTER/MARK** button to open the **INPUT SETTING** screen.

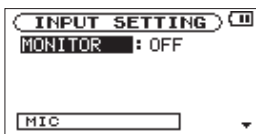

- 3 Turn the wheel to open the following screen.

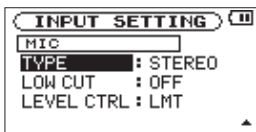

This screen has the following mic input settings. Use the **◀◀** and **▶▶** buttons as well as the wheel to set the items.

#### TYPE:

Set this to **STEREO** (default) or **MONO** as appropriate for the connected mic or mics. When set to **MONO**, the same signal will be sent to both left and right channels.

#### LOW CUT:

Use this to set the cutoff frequency of the low-cut filter used on the mic inputs to 40Hz, 80Hz or 120Hz. The default value is **OFF**.

#### LEVEL CTRL:

Set the recording level control function used on the mic inputs. The default value is **LMT**. (See "Using the level control function" on page 32.)

When set to **LMT** (limiter), the input gain will be adjusted automatically according to the analog input level, so that the recording level will not be distorted even if the input signal is very loud.

When set to **AUTO** (auto gain control), the gain is automatically adjusted to make the volume as even as possible. The gain increases for low-level input signals, and the gain decreases for high-level input signals.

#### NOTE

- When the input is **LINE 1/2**, regardless of the **TYPE** setting, the inputs will always be treated as **STEREO**.
- When the input is **LINE 1/2**, regardless of the **LOW CUT** setting, this function will always be **OFF**.
- When the **LEVEL CTRL** setting is **AUTO**, the volume will be automatically adjusted, so the **INPUT** knob is disabled.
- When the input is **LINE 1/2**, regardless of the **LEVEL CTRL** setting, it will always function as **LMT** (limiter).
- When **TYPE** is set to **MONO**, the recording will not be a mono file. Rather, it will be a stereo file with the same signal recorded on both left and right channels.

#### CAUTION

When recording with microphones, use headphones for monitoring. If you use speakers for monitoring, the sound output from the speakers will also be input resulting in poor recording quality and possibly noisy feedback.

#### TIP

- If noise from air conditioning or wind during an outdoor performance, for example, is being input, try setting the **LOW CUT** item to any value other than **OFF**.
- During live performances and at other times when unexpected loud noises are input, set the **LEVEL CTRL** item to **LMT** to prevent overloads and allow recording without distortion.

## Adjusting the analog input level

Before starting recording, the analog input level should be adjusted to prevent the recorded sounds or signals from being distorted due to excessively large input signals or from being inaudible due to excessively low input signals compared to noise.

In addition to manual adjustment, the unit has the following two level adjustment functions: auto gain control and limiter. Any of these can be used as required.

### TIP

In addition to adjusting the analog input level, try changing the distance and angle between the microphone and the sound source. The angle and distance of the microphone can also change the character of the recorded sound.

## Manually adjusting the analog input level

The following procedures explain how to set the levels.

### NOTE

When the level control function is set to auto gain control (**AUTO** appears at the top left of the recording screen), the analog input level cannot be adjusted manually. If you want to adjust the analog input level manually, set the **LEVEL CTRL** item to **LMT** on the **INPUT SETTING** screen. (See “Using the level control function” on page 32.)

- 1 Move the **MIC GAIN** switch on the bottom of the recorder to the setting you want.

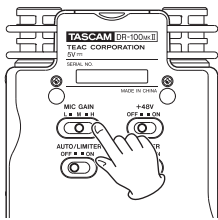

### MIC GAIN

#### L (LOW)

Use to record band performances and other loud sounds or close sound sources.

#### M (MID)

Use to record acoustic guitars and wind instruments, for example.

#### H (HIGH)

Use to record meetings, voices and other quiet sounds or distant sound sources.

### NOTE

- The DR-100MKII has been designed with high gain to enable it to record even very quiet sounds. For this reason, if using an AC adaptor when the **MIC GAIN** is set to **H** (HIGH), touching the mics could cause noise (hum or modulation) to be heard depending on placement

conditions. To avoid this, do not touch the built-in mics when recording with them.

- When the input is set to **LINE 1/2**, the **MIC GAIN** setting is disabled.
- 2 Press the **RECORD** [●] button to start recording standby.

The **RECORD** indicator will blink and the recording screen will open.

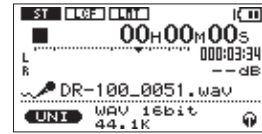

- 3 Adjust the analog input level using the **INPUT** knob on the right side panel.

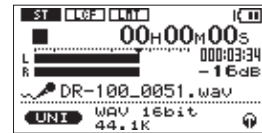
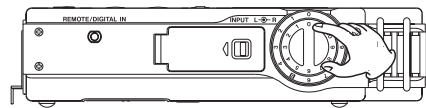

The **PEAK** indicator to the left of the display lights red when the input level is too high.

A ▼ mark is provided at -16 dB on the level meters. Set the analog input level so that the indicator bars move to and fro with this mark at about the center without causing the **PEAK** indicator to light red when the loudest sounds occur.

### NOTE

- Press the **STOP** [■] button to exit recording standby.
- When the **MIC GAIN** switch is set to **M** (MID), if the level meters do not extend very far even as the **INPUT** volume setting approaches **10**, set the **MIC GAIN** to **H** (HIGH). On the other hand, if the level meters stay extended even as the **INPUT** volume setting approaches **0**, set the **MIC GAIN** to **L** (LOW).

### CAUTION

When in recording standby or during recording, the speaker does not output sound even if the **SPEAKER** switch is enabled. Connect headphones to the Ω jack on the left side panel if you want to adjust the level or record while monitoring the input.

Use the Ω/**SP OUTPUT** volume control to adjust the monitoring volume. This does not affect the sound to be recorded.

### TIP

- In addition to adjusting the input volume, try adjusting the distance and angles between the mics and sound sources.

## 4 – Recording

- Use the auto gain control and limiter functions to prevent loud sound sources from distorting when recording. (See “Using the level control function” on page 32.)

### Using the level control function

Set the recording level control function to be used with microphone input.

- 1 Set the **AUTO/LIMITER** switch on the bottom of the recorder to **ON**.

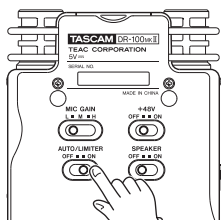

- 2 Press the **MENU** button to open the **MENU** screen.
- 3 Use the wheel to select the **INPUT SETTING** menu, and press the **ENTER/MARK** button to open the **INPUT SETTING** screen.
- 4 Use the wheel to open the following screen.

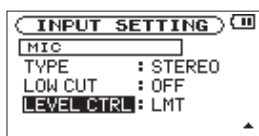

- 5 Use the **◀◀** and **▶▶** buttons as well as the wheel to set the **LEVEL CTRL** item.

#### LMT (default)

The input gain is adjusted in response to the analog input level, so that even if the input volume is very loud recording will occur at a level without distortion.

#### AUTO

The gain is automatically adjusted to make the volume as even as possible. The gain increases for low-level input signals, and the gain decreases for high-level input signals. This is useful for recording at the same level people in a meeting who are at different distances from the microphones, for example.

#### NOTE

- When set to **AUTO** (auto gain control), the input gain is adjusted automatically, so the **INPUT** volume control has no effect.
- When the input is **LINE 1/2**, regardless of the setting, it will always function as **LMT** (limiter).

## Recording

The following explanation assumes that you have already set the input source and adjusted the analog input level and that the Home Screen is open.

- 1 Press the **RECORD** [●] button to put the unit in recording standby.

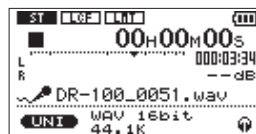

The screen shows the recording file name, the input source, the recording audio file type and sampling frequency. Please confirm that these are as desired before starting recording.

#### NOTE

When the **MONITOR** item is set to **ON** on the **INPUT SETTING** screen so that input sounds can always be monitored, a popup menu where you can turn overdubbing **ON** or **OFF** will appear. In this case, select **OFF** before proceeding to step 2.

- 2 Press the **RECORD** [●] button again to start recording.

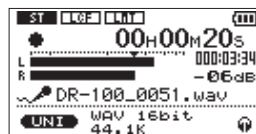

When recording starts, the **RECORD** indicator lights continuously, and the display shows the elapsed recording time and the remaining recording time.

- 3 Press the **STOP** [■] button to end recording and create the audio file.

To pause recording, press the **RECORD** [●] or **PLAY/PAUSE** [▶/||] button. Press the **RECORD** [●] or **PLAY/PAUSE** [▶/||] button again to restart recording in the same file. If you press the **STOP** [■] button after pausing a recorded audio file up to the moment that you paused recording is created.

## Dividing files and creating new files while recording

### Creating new files manually while recording (track incrementing)

You can manually split a recording by creating a new file.

Press the **▶▶|** button while recording.

#### NOTE

- When new files are created, incremental numbers are added to the end of each file name.
- A new file cannot be created if the total number of files and folders would exceed 999.
- Files shorter than two seconds cannot be created.
- If the name of a newly created file would be the same as that of an existing file, the number will be incremented until the new file has a unique name.
- Track increment is not possible in OVERDUB mode.

### Creating new files automatically while recording (automatic track incrementing)

Without pausing recording, a new file can be created automatically during recording when a file size or analog input level set in advance is exceeded. (See “Selecting file format, sampling frequency, and maximum file size” on page 27 and “Start new files automatically during recording (TRK INC)” on page 36.)

### Automatically cutting silences during recording

The unit can be set to automatically pause recording when it detects silence, and then restart recording when the signal is input again. (See “Enabling automatic recording” on page 35 and “Automatically pausing recording (PAUSE)” on page 36.)

This does not create new files, but cuts unnecessary silences, reducing the amount of card space used. Moreover, a mark is automatically added at the time when the unit pauses, making division after recording easy. (See “Moving to a mark position” on page 37.)

## Dividing a file manually (DIVIDE)

You can split a recorded file into two files at any position you like. This is convenient for splitting a continuous recording into multiple files.

- 1 Select a file to be divided using the **◀◀** or **▶▶** button or the **BROWSE** screen.
- 2 Press the **MENU** button to open the **MENU** screen.
- 3 Use the wheel to select **DIVIDE** menu item.



- 4 Press the **ENTER/MARK** button to open the **DIVIDE** screen.

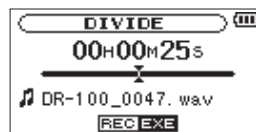

- 5 Use the wheel to determine where the file will be divided, and press the **RECORD [●]** button.

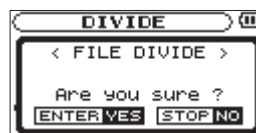

- 6 Press the **ENTER/MARK** button to divide the file, or press the **STOP [●]** button to cancel the operation and return to the **DIVIDE** screen.

#### NOTE

- When the **DIVIDE** screen is open, you can press the **PLAY/PAUSE (▶/||)** button and to set the divide position while playing the track.
- After dividing a file, two new files with “\_a” and “\_b” added to the end of the original file name are created. For example if the original filename is “DR-100\_0000.wav” then the new files will be named “DR-100\_0000\_a.wav” (the recording before the division point) and “DR-100\_0000\_b.wav” (the recording after the division point).
- MP3 files cannot be divided.
- If the SD card has insufficient open space, division might not be possible.
- Division is not possible if the file name would become more than 200 characters long.
- Division is not possible if a file that already exists has the same name as the name that would be given to a new file created by division.

#### TIP

- Add marks during recording at positions where you want to divide a file.
- Marks can be added manually (see “Adding marks manually during recording and playback” on page 36) or automatically when the unit detects silence (see “Automatically adding marks when recording (MARK)” on page 35). These marks can be easily located after recording (see “Moving to a mark position” on page 37).

## 4 – Recording

### Recording playback and input sounds together (overdubbing)

When an audio file is playing back, you can record the playback sound together with the input sound. This creates a new file and does not overwrite the playback file.

#### NOTE

- You cannot overdub if input monitoring is OFF or the PRE REC function is ON.
- You cannot overdub WAV files with 96kHz sampling frequency.
- When overdubbing, the automatic recording function is disabled.
- When overdubbing, you cannot start new files manually.
- You cannot pause during overdubbing. (You cannot use the **RECORD** [●] button.)
- The file type/sampling frequency of the playback file is preserved regardless of the file type/sampling frequency setting for overdub recording.

### Select the file you want to overdub

Use the **◀◀** and **▶▶** buttons or the **BROWSE** screen to select that files that you want to overdub.

#### NOTE

See "5 – Working with Files and Folders (BROWSE Screen)" on page 39 for selecting files using the **BROWSE** screen.

### Monitoring input signals

You can set the recorder to allow listening to both the playback and input signals at the same time.

- 1 Press the **MENU** button to open the **MENU** screen.
- 2 Use the wheel to select the **INPUT SETTING** menu, and press the **ENTER/MARK** button to open the **INPUT SETTING** screen.
- 3 Use the wheel to select **MONITOR** and press the **▶▶** or **ENTER/MARK** button.

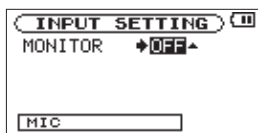

- 4 Use the wheel to set **MONITOR** to **ON** (default value: **OFF**) to enable monitoring of the input signal.
- 5 After completing the setting, press the **HOME** button to return to the Home Screen.

#### TIP

In addition to overdubbing, you can also use this setting above to practice singing or playing along with recorded (or imported) audio files. You can even use it for karaoke.

#### NOTE

You cannot change this setting during recording or when in recording standby.

### Adjusting the input and playback sound levels

- 1 Press the **PLAY/PAUSE** [▶/||] button to start playback of the file that will be output together with the input sound.
- 2 Press the **MENU** button to open the **MENU** screen.
- 3 Use the wheel to select the **MIX BALANCE** menu, and press the **ENTER/MARK** button to open the **MIX BALANCE** screen.



- 4 Use the wheel to adjust the level of the playback sound. The setting range is 0–20 (default: 20).
- 5 After completing the setting, press the **HOME** button to return to the Home Screen.

#### NOTE

- You cannot adjust this when input monitoring is OFF. (See "Monitoring input signals" on page 34.)
- When input monitoring is ON (and during overdub recording), the **PEAK** indicator shows the maximum level of the combined input and playback signals.

### Recording an overdub

- 1 Press the **RECORD** [●] button to start recording standby.

A popup menu that you can use to set **OVERDUB** to **ON** or **OFF** appears on the recording screen.

The name of the file being recorded, the input source, and the format and sampling frequency of the recorded audio file are shown on the recording screen, so you can check them before starting.

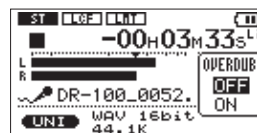

- 2 Use the wheel to select **ON** in the **OVERDUB OFF/ON** popup menu.

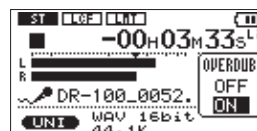

- 3 Press the **RECORD** [●] button to start overdubbing. When recording starts, the **RECORD** indicator lights, and the elapsed recording time or the remaining recording

time appear on the recording screen. In addition, the name of the file being played back appears at the bottom of the screen.

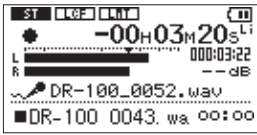

The following popup message appears if the selected file cannot be played back.



#### 4 Press the STOP [■] button to stop recording.

##### NOTE

You cannot overdub when the recording format is MP3. Select WAV 16bit or WAV 24bit regardless of the format of the playback file. (See “Selecting the file format, sampling frequency, and maximum file size” on page 27.) When overdubbing the sampling frequency will match the sampling frequency of the playback file regardless of the sampling frequency setting.

### Automatic recording (AUTO REC)

This function allows the unit to respond to input sound levels and start and pause recording, as well as set marks and create new files, for example.

This function is convenient for recording only when people are speaking during meetings, creating marks for finding the starts of songs and dividing files after recording, and automatically dividing files.

To set the automatic recording function, press the **AUTO** button to open the **AUTO REC** screen.

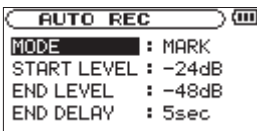

Make the following settings on this screen.

##### MODE

Set the automatic recording function mode. The mode options are **MARK** (default), **PAUSE** and **TRK INC**.

- MARK** : Automatically adds marks during recording
- PAUSE** : Automatically pauses during recording
- TRK INC** : Automatically creates new files during recording

##### START LEVEL

Signal is judged to have been input when it exceeds this level. Options are OFF, -6dB, -12dB (default), -24dB and -48dB.

##### END LEVEL

Signal is judged to have stopped when it becomes less than this level. Options are OFF, -6dB, -12dB, -24dB (default) and -48dB.

##### END DELAY

Time until the signal is determined to have stopped. The setting range is 1sec-5sec (default: 5sec).

##### NOTE

- If you press the **AUTO** button when recording or in recording standby, the current **AUTO REC** setting can be checked.
- When **AUTO REC** is on, the **RECORD** [●] button will blink more rapidly than usual in recording standby.
- When overdubbing, you cannot use the automatic recording function.

### Enabling automatic recording

When the input signal exceeds the **START LEVEL** recording begins automatically.

##### NOTE

The **MODE** setting does not affect this function.

- 1 Press the **AUTO** button to open the **AUTO REC** screen.
- 2 Set the value of the **START LEVEL** item.
- 3 Press the **HOME** button to return to the Home Screen.
- 4 Press the **RECORD** [●] button while holding down the **AUTO** button to put the unit into recording standby.  
Recording starts automatically when the input signal exceeds the **START LEVEL**.
- 5 Press the **STOP** [■] button to stop automatic recording.

### Automatically adding marks when recording (MARK)

The unit can be set to automatically add marks to files during recording after they become less than the **END LEVEL** setting and the **END DELAY** time passes. Marks can also be automatically added when the input signal exceeds the **START LEVEL** setting again.

- 1 Press the **AUTO** button to open the **AUTO REC** screen.
- 2 Set the **MODE** item to **MARK**.

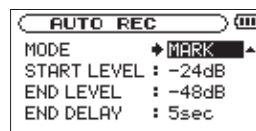

- 3 Set the value of the **START LEVEL** item.



## 4 – Recording

- 4 Set the value of the **END LEVEL** item.
- 5 Press the **HOME** button to return to the Home Screen.
- 6 Press the **RECORD** [●] button while holding down the **AUTO** button to put the unit into recording standby.  
Recording starts automatically when the input signal exceeds the **START LEVEL** value.
- 7 Press the **STOP** [■] button to stop automatic recording.

### NOTE

You can also add marks manually. (See “Adding marks manually during recording and playback” on page 36.)

### Automatically pausing recording (PAUSE)

You can set the unit to automatically pause after the input level of the recording becomes less than the **END LEVEL** setting and the **END DELAY** time passes.

- 1 Press the **AUTO** button to open the **AUTO REC** screen.
- 2 Set the **MODE** item to **PAUSE**.

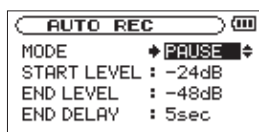

- 3 Set the value of the **END LEVEL** item.
- 4 Set the value of the **END DELAY** item.
- 5 Press the **HOME** button to return to the Home Screen.
- 6 Press the **RECORD** [●] button while holding down the **AUTO** button to put the unit into recording standby.  
Recording starts automatically when the input signal exceeds the **START LEVEL** value.
- 7 Press the **STOP** [■] button to stop automatic recording.

### Start new files automatically during recording (TRK INC)

A new file can be created automatically during recording when, after once becoming less than the end level, the input signal exceeds the start level again.

- 1 Press the **AUTO** button to open the **AUTO REC** screen.
- 2 Set the **MODE** item to **TRK INC**.

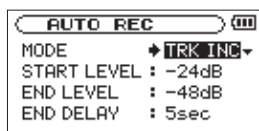

- 3 Set the value of the **START LEVEL** item.
- 4 Set the value of the **END LEVEL** item.
- 5 Press the **HOME** button to return to the Home Screen.

- 6 Press the **RECORD** [●] button while holding down the **AUTO** button to put the unit into recording standby.  
Recording starts automatically when the input signal exceeds the **START LEVEL** value.
- 7 Press the **STOP** [■] button to stop automatic recording.

### NOTE

- You can also create new files manually. (See “Creating new files manually while recording (track incrementing)” on page 33.)
- When new files are created, incremental numbers are added to the end of each file name.
- A new file cannot be created if the total number of files and folders would exceed 999.
- Files shorter than two seconds cannot be created.
- If the name of a new created file would be the same as that of an existing file, the number will be incremented until the new file has a unique name.

## Mark function

### Adding marks manually during recording and playback

Press the **ENTER/MARK** button during recording or playback to add a mark manually at the position you want. When you add a mark, its number appears in a popup at the bottom of the screen.

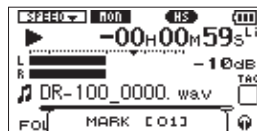

### NOTE

- A mark is automatically added when you restart recording after temporarily pausing.
- Mark information is stored in the file with numbers between 01–99. The maximum number of marks in a file is 99.
- When you add a mark during playback, the file is not immediately saved. Rather, it is saved the next time playback is stopped. If you press the **◀** or **▶** button to change takes before saving, the added marks will not be saved.
- When using the built-in mics, the sound of pressing the button when adding a mark could be recorded. To avoid this, use a remote control to add marks.



## Moving to a mark position

You can move to marks in the currently selected file when paused and during playback.

You can use this function to identify points to create shortcuts to the beginning of songs, for example.

**Press the  $\lll$ / $\ggg$  buttons while pressing and holding the ENTER/MARK button during playback or when stopped.**

### NOTE

You cannot move to a mark in a different file.

## Clearing Marks

While pressing the ENTER/MARK button press the STOP [■] button to clear the nearest mark earlier in the file.

When you clear a mark, its number appears in a popup at the bottom of the screen.

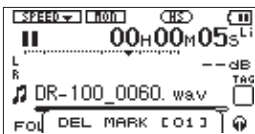

## Recording the moment before pushing RECORD (PRE REC)

By using prerecording, when the unit is in recording standby you can record up to two seconds of the signal input before the RECORD [●] button is pushed to start recording.

- 1 Press the MENU button to open the MENU screen.
- 2 Use the wheel to select REC SETTING, and press the ENTER/MARK button.

The REC SETTING screen appears.

- 3 Use the wheel to select the PRE REC item and press the  $\ggg$  or ENTER/MARK button.
- 4 Use the wheel to set the PRE REC item to ON.

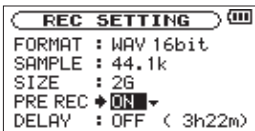

### TIP

By using this in combination with the auto-record function, you can record events without losing the beginnings of sounds.

### NOTE

- If the amount of time in record standby is less than two seconds, the sound for that amount of time is recorded.
- You cannot use the PRE REC function with overdub recording. When overdubbing set the PRE REC item OFF.

- When you turn the prerecording function ON, you should turn the record delay function OFF. If both are ON, only prerecording will function.

## Delaying the start of recording (REC DELAY)

This function allows you to delay the start of recording by 0.3 seconds (fixed interval) after the RECORD [●] button is pressed.

This is useful when you want to avoid recording the sound of pressing the RECORD [●] button.

- 1 Press the MENU button to open the MENU screen.
- 2 Use the wheel to select the REC SETTING menu item, and press the ENTER/MARK button.
- 3 Use the wheel to select the DELAY item, and press the  $\ggg$  or ENTER/MARK button.
- 4 Use the wheel to set the DELAY item to ON.

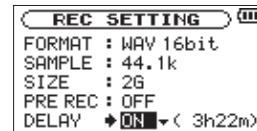

### NOTE

Set PRE REC to OFF when you set REC DELAY to ON.

## 4 – Recording

### Recording duration

The table below shows the maximum recording time on SD/SDHC cards of different capacities for different file formats for recording.

File format (recording setting)			SD/SDHC card capacity (hours:minutes)			
			1 GB	2 GB	4 GB	8 GB
WAV	16 bit	44.1 kHz	1:34	3:08	6:17	12:35
		48 kHz	1:26	2:53	5:46	11:33
		96 kHz	0:43	1:26	2:53	5:46
	24 bit	44.1 kHz	1:02	2:05	4:11	8:23
		48 kHz	0:57	1:55	3:50	7:42
		96 kHz	0:28	0:57	1:55	3:51
MP3	32 kbps	44.1 kHz/48 kHz	69:25	138:51	277:11	554:58
	64 kbps	44.1 kHz/48 kHz	34:42	69:25	138:35	277:29
	96 kbps	44.1 kHz/48 kHz	23:08	46:17	92:23	184:59
	128 kbps	44.1 kHz/48 kHz	17:21	34:42	69:17	138:44
	192 kbps	44.1 kHz/48 kHz	11:34	23:08	46:11	92:29
	256 kbps	44.1 kHz/48 kHz	8:40	17:21	34:38	69:22
	320 kbps	44.1 kHz/48 kHz	6:56	13:53	27:43	55:29

- The recording times shown above are estimates. They might differ depending on the SD/SDHC card in use.
- The recording times shown above are not continuous recording times, but rather they are the total possible recording times for the SD/SDHC card.

# 5 – Working with Files and Folders (BROWSE Screen)

On the **BROWSE** Screen, you can view the contents of the Music Folder, which contains the audio files on the SD card that you can use with the DR-100MKII. On this screen, you can also play and erase selected audio files, create folders, add files to the playlist and so on. (See “Playlist” on page 43.)

## TIP

By connecting this unit with a computer using a USB cable or connecting the SD card directly to a computer, you can use a computer to change the folder structure inside the MUSIC folder and delete files in it. Furthermore, you can change file names from the computer.

To open the **BROWSE** Screen, press the **MENU** button to open the **MENU** screen. Use the wheel to select **BROWSE** and press the **ENTER/MARK** button.

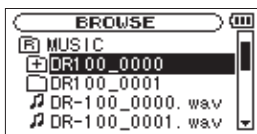

The contents of the folder that contains the file that was selected on the Home Screen before the **BROWSE** Screen was opened appears on the display.

## Screen navigation

On the **BROWSE** Screen, folders and music files appear in a hierarchical structure much like they would appear on a computer. On the DR-100MKII, folders can only be used to two levels.

- Use the wheel to select files and folders.
- When a folder is selected, press the **▶▶** button to show the contents of that folder.
- When a file or folder is selected, press the **◀◀** button to exit the currently open folder and go to a higher level in the folder structure.
- When a file or folder is selected, press the **ENTER/MARK** button to open the pop-up window.
- When a file is selected (highlighted), if you press the **▶▶** button, the file will be loaded and the Home Screen will reopen.

This folder that contains this file becomes the current folder, and new recorded file will be saved in this folder. If the playback area has been set to **FOLDER**, this folder becomes the new playback area.

## Icons on the BROWSE screen

The meanings of icons that appear on the **BROWSE** Screen are as follows.

### Music Folder (MUSIC)

The **MUSIC** Folder is the highest (root) level folder in the hierarchy shown on the **BROWSE** Screen.

### Audio file

This icon appears before the names of music files.

### Plus folder

This icon shows folders that contain subfolders.

### Plain folder

This icon shows folders that do not contain subfolders.

### Open folder

The contents of the folder marked with this icon currently appear on this screen.

## File operations

Select the desired audio file on the **BROWSE** Screen and press the **ENTER/MARK** button to open the pop-up window that is shown below.

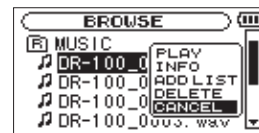

Use the wheel to select the item you want from the following list and press **ENTER/MARK** button to execute it.

### PLAY

Return to the Home Screen and start playback of the selected file. If the playback area is set to **FOLDER**, the folder that contains this file becomes the playback area.

### INFO

Information (date/time, size) about the selected file appears. Press the **ENTER/MARK** button again or press the **STOP [■]** button to return to the **BROWSE** screen.

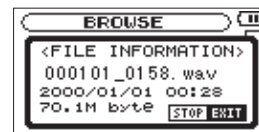

### ADD LIST

Adds the selected file to the playlist. (See “Playlist” on page 43.)

## 5 – Working with Files and Folders (BROWSE Screen)

### DELETE

A message appears to confirm that you want to delete the selected file. Press the **ENTER/MARK** button to erase the file and **STOP [■]** button to cancel the deletion operation.



### CANCEL

The operation for the selected file is canceled, and the pop-up menu is closed.

## Folder operations

Select the desired folder on the BROWSE Screen and press the **ENTER/MARK** button to open the pop-up window that is shown below.

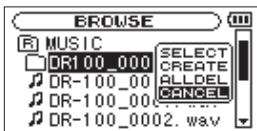

Use the wheel to select the item you want from the following list and press the **ENTER/MARK** button to execute it.

### SELECT

Returns to the Home Screen and selects the first file in the folder. Regardless of the previous setting, the playback area is set to FOLDER, and this folder becomes the new playback area. When recording, files are created in this folder.

### CREATE

A pop-up appears to confirm that you want to create a new folder.



Press the **ENTER/MARK** button to create a new folder or press the **STOP [■]** button to cancel the operation of a folder.

However, if you select CREATE when you are in a second-level subfolder, a "Layer too deep." popup message appears and a new folder cannot be created.

### ALL DEL

A pop-up message appears to confirm that you want to delete all the files in the selected folder at once.

Press the **ENTER/MARK** button to erase the files or press the **STOP [■]** button to cancel.



### NOTE

You cannot erase read-only files and files that are not recognized by this unit.

### CANCEL

The operation for the selected file is canceled, and the pop-up menu is closed.

## Add identification tags to files (QUICK TAG)

You can easily add symbols to file names for identification. This is useful for distinguishing important files from unimportant ones, for example.

- 1 When the Home Screen is open, press the QUICK button to open a pop-up menu.

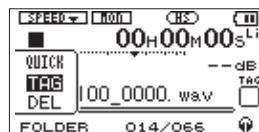

- 2 Use the wheel to select TAG, and press the ENTER/MARK button.

The QUICK TAG screen appears.



- 3 Use the wheel to select a symbol (o or x), and press the ENTER/MARK button to add it to the name, or press the STOP [■] button to cancel adding a symbol.

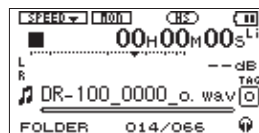

If you add a tag the filename changes as follows. For example, if the file name is "DR-100\_0000.wav" then the new filename becomes "DR-100\_0000\_o.wav" or "DR-100\_0000\_x.wav".

### NOTE

If an MP3 file is selected, its ID3 tag information will be given priority. In this case, file names with identification tags added to the end using the QUICK TAG function will not be shown. Check the identification tag information on the Home Screen or check the BROWSE screen to see this.

### Delete the selected file (QUICK DEL)

You can easily delete the selected file.

- 1 When the Home Screen is open, press the QUICK button to open a popup menu.

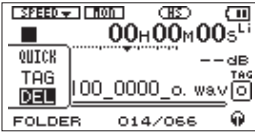

- 2 Select DEL from the menu, and press the ENTER/MARK button.

The QUICK DELETE screen appears.



- 3 Press the ENTER/MARK button to delete the file, or press the STOP [■] button to cancel deletion.

# 6 – Playback

## Selecting files for playback (skip)

On the Home Screen, you can use the ◀◀ and ▶▶ buttons to select the playback track. The files that you can select are determined by the playback area setting.

Limiting the playback area makes track selection easier when you have numerous recorded and copied tracks on the SD card.

On the PLAY MODE Screen, you can select all files, the current folder or the playlist as the playback area. You can also use the BROWSE Screen to set a folder as the playback area.

### NOTE

On the BROWSE Screen, regardless of the playback area setting, you can select any file on the card that you want.

## Setting the mode

Set the operation mode used for playback. (See “Mode selection” on page 25.) Depending on the operation mode, the files that can be played will differ.

## Adjusting playback volume

The volume of output through the built-in speaker or the Ω connector can be adjusted using the Ω/SP OUTPUT volume control.

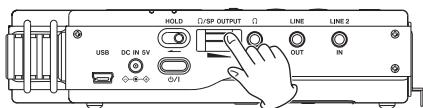

## Setting the playback area (AREA)

Set the playback area for repeat and ordinary playback on the PLAY MODE screen.

- 1 Press the MENU button to open the MENU Screen.
- 2 Use the wheel to select PLAY MODE and press the ENTER/MARK button.

The PLAY MODE screen appears.

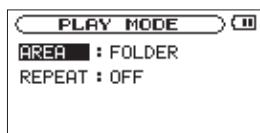

- 3 Use the wheel to select AREA, and press the ▶▶ or ENTER/MARK button.

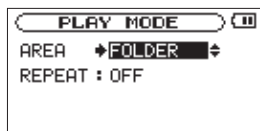

- 4 Use the wheel to set the playback area.

### ALL FILES

Set the playback area as all files in the Music Folder on the SD card.

### FOLDER (default)

Set the playback area as all the files in the currently selected folder.

### PLAYLIST

Set the playback area as the files in the playlist. (See “Playlist” on page 43.)

You can add any file that you want to the playlist.

If there is no playlist defined, a No PLAYLIST pop-up appears.



- 5 Press the HOME button to return to the Home Screen.

### NOTE

The current playback area setting appears in the lower left of the Home Screen.

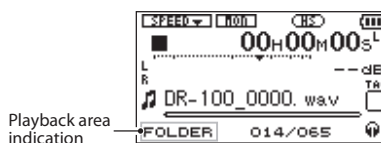

## Selecting a folder for the playback area (1)

Regardless of the current playback area, if you select a folder on the BROWSE Screen, the playback area changes to the selected folder.

- 1 Press the MENU button to open the MENU screen.
- 2 Use the wheel to select BROWSE, and press the ENTER/MARK button.

BROWSE screen appears.

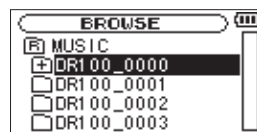

- 3 Use the wheel to select a folder.

For an explanation of how to use the BROWSE Screen, see “Screen navigation” on page 39.

- 4 Press the ENTER/MARK button to open the following pop-up window.



- 5 Use the wheel to select SELECT, and press the ENTER/MARK button.**

The display returns to the Home Screen. The first file in the folder is selected, and the unit is stopped.

Regardless of the previous setting, the playback area is set to FOLDER, and this folder becomes the playback area.

## Selecting a folder for the playback area (2)

When the playback area is set to FOLDER, if you select a file on the BROWSE Screen, the folder that contains the selected file becomes the playback area.

- 1 Press the MENU button to open the MENU screen.**
- 2 Use the wheel to select BROWSE, and press the ENTER/MARK button.**

BROWSE screen appears.

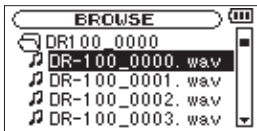

- 3 Use the wheel to select a folder that contains the file you want to play.**  
For an explanation of how to use the BROWSE Screen, see “Screen navigation” on page 39.
- 4 Press the ►►► button.**
- 5 Use the wheel to select the desired file.**
- 6 Press the ENTER/MARK button to open the following popup menu.**

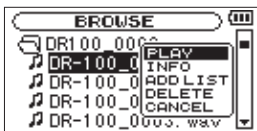

- 7 Use the wheel to select PLAY and press the ENTER/MARK button to return to the Home Screen and start playback of the selected file.**

If the playback area is set to FOLDER, the folder that contains this file becomes the playback area.

## Playlist

You can make a list of files for playback (playlist). On the PLAY MODE Screen if you select PLAYLIST for the AREA item, you can set playback to just the files in your playlist.

If there are no files in the playlist, the No PLAYLIST popup message appears.

### Adding files to the playlist

- 1 Press the MENU button to open the MENU screen.**
- 2 Use the wheel to select BROWSE, and press the ENTER/MARK button.**

BROWSE screen appears.

#### NOTE

For an explanation of how to use the BROWSE Screen, see “5 – Working with Files and Folders (BROWSE Screen)” on page 39.

- 3 Use the wheel to select the file you want to add to the playlist, and press the ENTER/MARK button.**  
A pop-up window appears.

#### NOTE

For details about how to select the file, see “Screen navigation” on page 39.

- 4 Use the wheel to select ADD LIST.**



- 5 Press the ENTER/MARK button.**

The file is added to the playlist and the popup window closes.

- 6 Repeat steps 3, 4, and 5 as necessary to add more files to the playlist. The files are numbered in the order that they are added.**

Tracks in the playlist are played back in the order that they were added.

## Editing the playlist

You can view and edit the playlist you have made on the PLAYLIST screen.

You can also use this screen to play files and to edit the playlist.

- 1 Press the MENU button to open the MENU screen.**
- 2 Use the wheel to select PLAYLIST, and press the ENTER/MARK button.**

PLAYLIST screen appears.

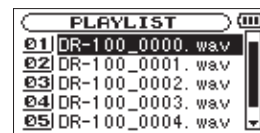

- 3 Use the wheel to select the file you want to edit, and press ENTER/MARK.**

A pop-up window appears.



- 4 Use the wheel to select the item, and press the ENTER/MARK button to cause the unit to work as follows.**

#### PLAY

Play the selected file and return to the Home Screen.



## 6 – Playback

### ALL CLR

A confirmation message appears to confirm that you want to remove all the files from the playlist. Press the **ENTER/MARK** button to remove all the files or the **STOP** [■] button to cancel this operation.

For this operation, it does not matter which file you select in step 3. All the files are removed from the playlist, but they are not erased from the SD card.



### DELETE

Remove the selected file from the playlist.

The file is removed from the playlist, but it is not erased from the SD card.

### MOVE

Select this to change the order of files in the playlist.

In addition to the file name, the file number also appears highlighted in inverse.

- Use the wheel to move the selected file to a different position in the playlist.

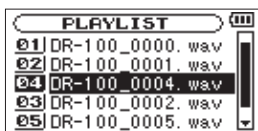

In the above example, the 4th file has been moved to the 3rd file position.

- Press the **ENTER/MARK** button.  
The display returns to the **PLAYLIST** screen.

### CANCEL

The operation for the selected file is canceled.

## Selecting files for playback (skip)

When the Home Screen is open, press the **I◀◀** and **▶▶I** buttons to select the file for playback.

If you press the **I◀◀** button when the playback position is located at the middle of a file, it will return to the beginning of that file. If you press the **I◀◀** button when located at the beginning of a file, the playback position will skip to the beginning of the previous file.

If you press the **▶▶I** button when located at the beginning of or middle of a file, the playback position will skip to the beginning of the next file.

### NOTE

- Only files in the playback area that is currently set can be selected for playback.
- The track name, file number and other file information for the currently playing file appear on the display.
- The ■ icon appears on the display when playback is stopped at the beginning of a file, and the || icon appears when playback is stopped in the middle of a file (paused).

## Playback

When the Home Screen is open and playback is stopped, press the **PLAY/PAUSE** (▶/||) button to start playback.

### NOTE

- Files in the playback area can be played.
- You can also choose files for playback by name on the **BROWSE** screen.

## Stopping

When the Home Screen is open and a track is playing back, press the **STOP** (■) button to stop playback at the current position.

Press the **STOP** (■) button again to return to the beginning of the file.

## Pausing (PAUSE)

When the Home Screen is open and a track is playing back, press the **PLAY/PAUSE** (▶/||) button to pause playback at the current position.

Press the **PLAY/PAUSE** (▶/||) button again to restart playback from that position.

## Rewinding and fast-forwarding (search)

When the Home Screen is open and a track is playing back or stopped, press and hold the **I◀◀** or **▶▶I** buttons to rewind or fast-forward and search the playback track.

### NOTE

You can set the search speed. (See “Search speed setting” on page 49.)

## Using the wheel to change the playback position

When the Home Screen is open and a track is playing back or stopped, you can use the wheel to change the playback position.

### NOTE

- The faster you turn the wheel, the more rapidly the position changes.
- No sound is output while the wheel is being turned.
- During playback, if you turn the wheel, playback will resume from the position where you stop turning.

## Repeat playback (REPEAT)

You can repeatedly playback one file or multiple files within a designated area.

- 1 Press the **MENU** button to open the **MENU** screen.
- 2 Use the wheel to select **PLAY MODE** and press the **ENTER/MARK** button.  
PLAY MODE screen appears.
- 3 Use the wheel to select **REPEAT** and press the **▶▶** or **ENTER/MARK** button.



- 4 Use the wheel to select a repeat mode.

### OFF (default)

All files in the playback area are played in sequence one time. (This setting is the ordinary playback mode.)

### SINGLE

The selected file is played once without repeating. The **SINGLE** icon appears on the Home Screen

### 1 REPEAT

The current file is played repeatedly. The **1 REPEAT** icon appears on the Home Screen.

### ALL REPEAT

All files in the selected playback area are played back repeatedly. The **ALL REPEAT** icon appears on the Home Screen.

### NOTE

If you start loop playback, the **REPEAT** item automatically switches to **OFF** if it is in a different mode.

- 5 After completing the setting, press the **STOP** [■] button to return to the Home Screen and start playback.

## Loop playback

With this function, you can continuously repeat (loop) the playback of a selection that you make.

- 1 During playback (or when paused), press the **I/O LOOP** button at the point where you want to start the loop playback interval.

The current playback position will be set as the starting (IN) point.

- 2 Press the **I/O LOOP** button at the point where you want to end the loop playback interval.

The current playback position will be set as the ending (OUT) point, and loop playback between the IN-OUT points will start. The starting (IN) and ending (OUT) points are shown as **I** and **O** at corresponding positions beneath the playback position bar on the Home Screen. In addition, the **I/O** icon also appears during playback.

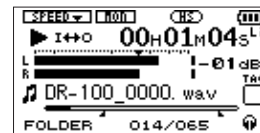

### NOTE

- The pop-up message of **I/O Too Short** appears if the section between the IN and OUT points is too short. Set them again. The section should be 1 second or longer.
- When the starting (IN) and ending (OUT) points are currently set, pressing the **I/O LOOP** button again will clear both points.
- You cannot set the IN and OUT points in different files.
- If you enable repeat playback, the loop settings will be cleared.
- IN and OUT point settings are lost when you select a different file.
- Setting accurate IN and OUT points might not be possible with Variable Bit Rate (VBR) format MP3 files.

## Special playback control functions

Not only can you use the DR-100MKII to change the tempo of track playback, you can even do this without changing the pitch.

### Setting the playback control functions

Use the **PB CONTROL** Screen to set the playback control functions. When the Home Screen is displayed, press and hold the **PB CONTROL** button to open the **PB CONTROL** Screen.

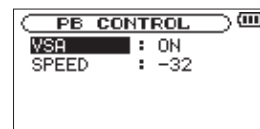

## 6 – Playback

Use the **◀◀** button, **▶▶** button and wheel to set each items.

After you finish making settings on this screen, press the **HOME** button (or press and hold the **PB CONTROL** button) to return to the Home Screen.

In the upper part of the Home Screen, the icons for the playback control functions that are currently active appear highlighted in inverse.

---

### Changing speed without changing pitch (VSA function)

The unit features the VSA (Variable Speed Audition) function that changes the playback speed without changing its pitch.

Use the **VSA** item to turn on or off the VSA function (default setting is **ON**).

#### NOTE

VSA function cannot be used when a WAV file that was recorded at 96 kHz sampling frequency is selected.

However, **SPEED** will be shown in the Home Screen and the setting of playback speed can be changed.

The VSA setting will not work with 96kHz files, but if you return to the Home Screen and use the **◀◀** and **▶▶** buttons, for example, to load a 44.1/48 kHz file the playback speed setting will become effective.

---

### Changing playback speed

Use the **SPEED** item to set the playback speed. Just setting the speed, however, does not enable the speed control function. After making the setting, press the **PB CONTROL** button to turn the speed control ON. When ON, the **SPEED** icon appears as black letters on a white background at the top of the Home Screen. Press the **PB CONTROL** button briefly to turn the speed control ON or OFF. This allows you to easily switch between the set speed and normal speed. The playback speed range is from **-50** (50%) to **16** (116%) (default setting is **-32**).

#### NOTE

Pressing the **PB CONTROL** button only turns the playback control function speed setting ON/OFF. Any other changes from default values made on the **PB CONTROL** screen are always ON.

# 7 – Connecting with a Computer

By connecting this unit with a computer using the USB cable, you can transfer audio files on the SD card in the unit to a computer, as well as transfer audio files on the computer to the SD card in the unit.

This unit can handle audio files of the following formats (only stereo files).

MP3: 32 kbps – 320 kbps, 44.1/48 kHz

WAV: 44.1/48/96 (HS mode) kHz, 16/24 bit

## Connecting a computer

Confirm that an SD card is properly inserted into the unit, and use the included USB cable to connect this unit with a computer.

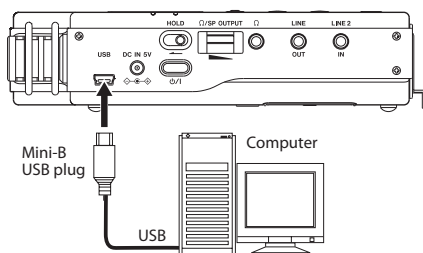

When connected, "connected... USB" appears on the screen of the recorder.

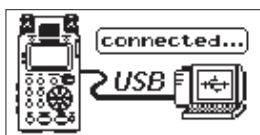

This unit appears on the computer screen as external volume named DR-100MK2.

### NOTE

- You cannot use this unit's other functions when it is connected to a computer by USB.
- Instead of connecting to a computer by USB, you can conduct the same operations by removing the SD card from the recorder and loading it on the computer directly or by using a card adaptor.
- If an SD card is not properly inserted before making the USB connection, "Can't Save Data" appears on the screen.

## Transferring files to a computer

- 1 Click the DR-100MK2 drive on the computer screen to show the MUSIC and UTILITY folders.
- 2 Open the MUSIC folder and drag and drop the files that you want to transfer to the computer to destinations of your choice.

## Transferring files from a computer

- 1 Click the DR-100MK2 drive on the computer screen to show the MUSIC and UTILITY folders.
- 2 Drag and drop files on the computer that you want to transfer to the unit to the MUSIC folder.

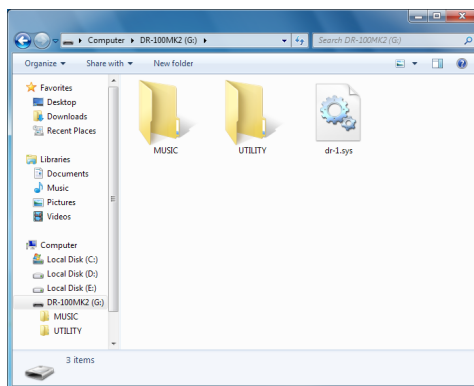

### TIP

- You can manage the MUSIC folder from the computer.
- You can create subfolders in the MUSIC folder up to the second level for use with this unit. The DR-100MKII cannot recognize subfolders and audio files on the third level or below.
- Since you can set the DR-100MKII to only play the contents of a specific folder, you can organize tracks into genres, artists or other categories as you like.
- If you name the subfolders and music tracks, these names will appear on the screen of this unit.

## Disconnecting from a computer

Before disconnecting the USB cable, use the proper procedures for your computer to unmount the DR-100MK2 (as an external drive). Then, disconnect the USB cable. The power turns off.

See the computer's operation manual for instructions about how to unmount an external drive.

# 8 – Settings and Information

## Using the INFORMATION screens

Various information about this unit can be checked on these screens. Follow these procedures to open the INFORMATION screen.

- 1 Press the **MENU** button to open the **MENU** screen.
- 2 Use the wheel to select **INFORMATION**, and press the **ENTER/MARK** button.

The **INFORMATION** screen contains the following four pages. Use the wheel to move through the pages.

### File information page (FILE)

Shows information about the currently loaded file.

### Card information page (CARD)

Shows the use status of the currently inserted SD card.

### System information page (SYSTEM)

Shows the unit's system setting information and firmware version.

### Power information page (BATTERY)

Shows usage information about the batteries installed in the recorder.

## File information page (FILE)

The **FILE** page shows information about the currently selected file.

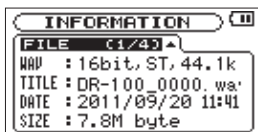

### WAV/MP3:

Shows the audio file type.

For WAV files, bit length, stereo/mono, and sampling frequency (Hz) also appear.

For MP3 files, the bit rate (kbps), CBR (constant bit rate) or VBR (variable bit rate) type, and sampling frequency (Hz) also appear.

### TITLE:

Shows the file name. If an MP3 file has ID3 tag title information that information appears.

### DATE:

Date of file creation

### SIZE:

File size

## Card information page (CARD)

The **CARD** page shows the status of the currently inserted SD card.

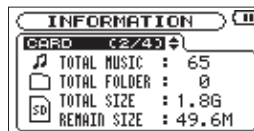

### TOTAL MUSIC:

Shows the number of playable files contained by the Music Folder.

### TOTAL FOLDER:

Shows the total number of folders in the Music Folder.

### TOTAL SIZE:

Shows the total SD card capacity.

### REMAIN SIZE/USED SIZE:

Shows the amount of unused/used capacity on the SD card.

Press the **◀◀** or **▶▶** button to switch between **REMAIN SIZE** and **USED SIZE**.

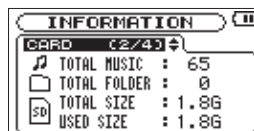

## System information page (SYSTEM)

The **SYSTEM** page shows information about the DR-100MKII's system settings and firmware version.



### CUE/REV SPD:

Shows the forward and backward search speed.

### AUTO OFF:

Shows the automatic power OFF setting.

### BACKLIGHT:

Shows the automatic backlight OFF setting.

### System Ver.:

Shows the system firmware version.

## Battery information page (BATTERY)

On the BATTERY page, usage information about the batteries in the recorder is shown.

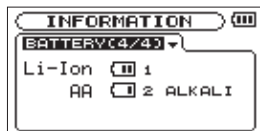

### Li-Ion:

Shows the amount of power remaining in the recorder's lithium-ion rechargeable battery.

The number to the right of the shows whether this is being used as the main (1) or secondary (2) battery power source.

### AA:

Shows the amount of power remaining in the recorder's AA batteries. The number to the right of the shows whether this is being used as the main (1) or secondary (2) battery power source.

ALKALI or Ni-MH shows the type of AA batteries in the recorder.

Alkaline batteries: ALKALI

Ni-MH batteries: Ni-MH

### NOTE

- When using an AC adaptor or TASCAM BP-6AA external battery pack, the is always shown instead of the remaining charge in the lithium-ion rechargeable battery.



- When the lithium-ion battery is set as the main battery and is in use, the remaining charge of the AA batteries might not be shown correctly depending on other conditions. (See "Setting the main battery source (MAIN)" on page 50.)

## Operation settings (SETUP)

On the SETUP screen, you can make various settings to make the unit easier to operate according to the environment where you are using it and other conditions. On this screen you can also initialize the unit and format SD cards.

Follow these procedures to open the SETUP screen.

- Press the MENU button to open the MENU screen.
- Use the wheel to select the SETUP menu and press the ENTER/MARK button to open the SETUP menu screen.

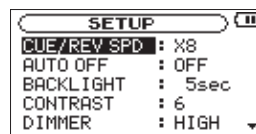

Use the items on the SETUP screen to make the following settings.

Use the and buttons and the wheel to set each item.

### Search speed setting

CUE/REV SPD sets the forward and backward search speed used when you press and hold the / buttons.

Setting options: X2, X4, X8 (default), X10

### Automatic power OFF setting

AUTO OFF sets the amount of time until the recorder turns OFF automatically after the last action or operation when running on battery power.

Setting options: OFF (default, does not turn off automatically), 3min, 5min, 10min, 30min

### Automatic backlight OFF setting

BACKLIGHT sets the amount of time until the backlight turns OFF automatically after the last operation when running on battery power.

Setting options: OFF (always unlit), 5sec (default), 10sec, 15sec, 30sec, ALWAYS (always lit)

### Display contrast setting

CONTRAST sets the display contrast.

Setting range: 1-20 (default value: 6)

### Backlight brightness setting

DIMMER sets the backlight brightness.

Setting options: HIGH (default), LOW

### Restoring default settings

Use the INITIALIZE item if you want to restore the various settings of this device to their factory defaults.

- Use the wheel to select INITIALIZE and press the ENTER/MARK button to select Exec.
- Press the ENTER/MARK button again to open a confirmation pop-up message.



- Press the ENTER/MARK button again to initialize the recorder. Press the STOP [■] button to cancel initialization.

## 8 – Settings and Information

### Using QUICK FORMAT

Use the **QUICK FORMAT** item to quick format the SD card. Using **QUICK FORMAT** erases all music files on the card and automatically creates new **MUSIC** and **UTILITY** folders as well as the “dr-1.sys” file that is necessary to use the SD card with the DR-100MKII.

- 1 Use the wheel to select **QUICK FORMAT**, and press the **ENTER/MARK** button to highlight **Exec.**
- 2 Press the **ENTER/MARK** button to open a pop-up confirmation window.



- 3 Press the **ENTER/MARK** button to execute the quick formatting, or press the **STOP [■]** button to cancel formatting.

### Using FULL FORMAT

Use the **FULL FORMAT** item to completely format the SD card.

Using **FULL FORMAT** erases all music files on the card and automatically creates new **MUSIC** and **UTILITY** folders as well as the “dr-1.sys” file that is necessary to use the SD card with the DR-100MKII.

Full formatting checks the memory for errors while formatting, so it takes more time than quick formatting.

- 1 Use the wheel to select **FULL FORMAT**, and press the **ENTER/MARK** to highlight **Exec.**
- 2 Press the **ENTER/MARK** button to open a pop-up confirmation window.



- 3 Press the **ENTER/MARK** button to execute the full formatting, or press the **STOP [■]** button to cancel formatting.

#### CAUTION

When formatting a card, the unit should be operating on AC power supplied through the PS-P520 adapter (sold separately) or batteries with sufficient remaining power. If the power fails during formatting, the formatting does not occur correctly.

### Setting the main battery source (MAIN)

When both the lithium ion battery and AA batteries are installed, you can set one as a main power source and the other as a backup. Usually the unit uses the main power source.

When the remaining power of the main battery source becomes low, the unit automatically switches to the backup, allowing continued operation.

The battery source currently used and the amount of remaining power it has are shown on the Home Screen.

- 1 Press the **MENU** button to open the **MENU** screen.
- 2 Use the wheel to select **BATTERY**, and press the **ENTER/MARK** button.

**BATTERY** screen appears.

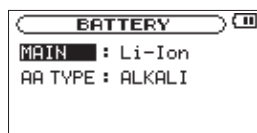

- 3 Use the **MAIN** item to set the main battery power source.

Options: **Li-Ion** (lithium ion battery, default), **AA**

#### CAUTION

- The power turns off if the backup battery source does not have enough charge. In this case, all recordings, settings and other data will be lost.
- The power supply will not automatically switch from the backup battery to the main battery. When operating on the backup battery, reset the main battery selection after changing it.

### Changing batteries when the power is on

If both the lithium ion battery and AA batteries are installed, you can change batteries while continuing to record and use other functions.

#### NOTE

In the following sections, for simplicity we refer to the main "battery" and backup "battery," even though the unit uses two AA batteries. Both AA batteries should be changed together.

#### ■ Changing the main battery

Before changing the main battery, confirm that its charge has become low enough that power has switched to the backup battery.

The unit turns OFF if you remove the main battery while it is being used.

If you must change the main battery even though it is in use, change the setting so that the backup battery becomes the main battery and confirm this operation on the Home Screen first.



Confirm that the replaced battery is installed properly before changing the unit setting to make it the main battery.

### NOTE

If the backup battery charge becomes less than a certain level, the **Current Main: AA** popup message appears, and even if you change the MAIN battery setting, the power source will not change while the unit is operating.

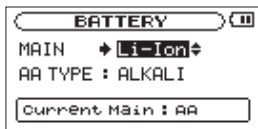

### ■ Changing the backup battery

You can change the backup battery at any time when the main battery is in use, but you should confirm on the Home Screen that the main battery has enough remaining charge.

The unit turns OFF if you remove the backup battery while it is being used.

## Setting the type of AA batteries (AA BATTERY)

You should set the type of AA batteries that you are using. This setting is used to show the amount of remaining battery charge and determine if the unit has enough power for normal operation.

- 1 Press the **MENU** button to open the **MENU** screen.
- 2 Use the wheel to select **BATTERY**, and press the **ENTER/MARK** button.  
BATTERY screen appears.
- 3 Use the **AA TYPE** item to set the AA battery type to be used.  
Options: ALKALI (Alkaline batteries, default), Ni-MH (Nickel metal hydride batteries)

## Setting the file name format

You can set the format of the names given to files when recorded by this unit.

- 1 Press the **MENU** button to open the **MENU** screen.
- 2 Use the wheel to select **FILE NAME**, and press the **ENTER/MARK** button.  
FILE NAME screen appears.

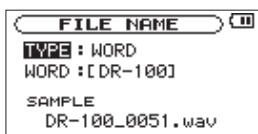

Use the **◀◀** and **▶▶** buttons and the wheel to set each item.

You can make the following settings with the items on this screen.

### File name format

Set the **TYPE** item to **WORD** or **DATE**.

Options: **WORD** (default), **DATE**

**WORD**: Six characters set with the **WORD** item are used as the file name, for example "DR-100\_0000.wav".

**Date**: The date is used as the file name, for example, "110912\_0000.wav".

### NOTE

The date is determined by the unit's internal clock setting. (See "Setting the date and time" on page 23.)

### Setting the file name (WORD)

In the **WORD** item, use the **◀◀** and **▶▶** buttons to move the cursor, and use the wheel to select the characters.

In addition to letters and numbers, the following symbols can also be used.

! # \$ % & ' ( ) + , - . ; = @ [ ] ^ \_ ` { } ~

# 9 – Using the REMOTE/DIGITAL IN jack

This unit has a **REMOTE/DIGITAL IN** jack to which you can connect a TASCAM RC-10 wired remote control or TASCAM RC-3F footswitch-type remote control (sold separately) that can be used to operate the unit.

You can also use the included digital input conversion cable to connect the recorder to external digital audio equipment.

## Footswitch (TASCAM RC-3F, sold separately)

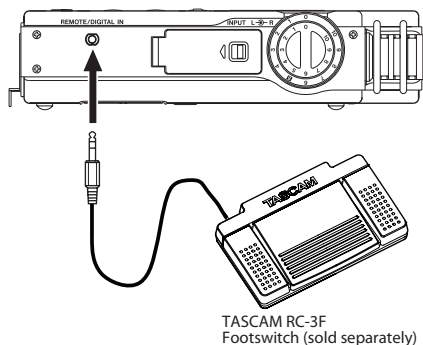

## Setting footswitch operation

Use the REMOTE/DIGI IN setting screen to make footswitch settings.

- 1 Press the MENU button to open the MENU screen.
- 2 Use the wheel to select REMOTE/DIGI IN, and press the ENTER/MARK to open the REMOTE/DIGI IN submenu.

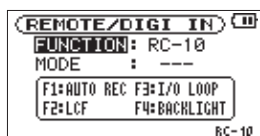

- 3 Use the wheel to select FUNCTION menu item, and press the ENTER/MARK or ►► button.
- 4 Use the wheel to change the FUNCTION item to RC-3F. (Default: RC-10).



- 5 Use the ◀◀ and wheel to select MODE item, and press the ENTER/MARK or ►► button.

## 6 Use the wheel to change the MODE item.

Options: PLAY (default), RECORD1, RECORD2, MINUTES

MODE	FOOT SW		
	L	C	R
PLAY	REW	PLAY/STOP	FWD
RECORD 1	STOP	REC/PAUSE	INC
RECORD 2	STOP	REC/PAUSE	MARK
MINUTES	REW	PLAY/STOP	SPEED CHANGE

- 7 Press the STOP [■] button to return to the Home Screen.

## Using the footswitch

Press a pedal on the footswitch to operate the unit. The function of each pedal corresponds to the assignment shown on the REMOTE/DIGI IN screen.

## Using digital input

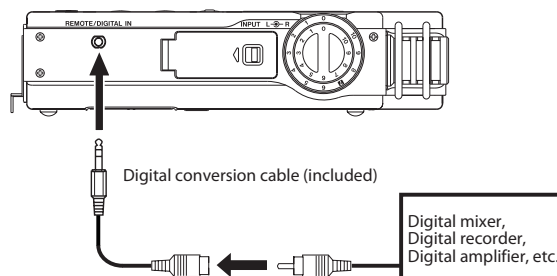

## Setting the digital input

Enable digital input on the REMOTE/DIGI IN setting screen.

- 1 Press the MENU button to open the MENU screen.
- 2 Use the wheel to select REMOTE/DIGI IN and press the ENTER/MARK button to open the REMOTE/DIGI IN setting screen.



- 3 Use the wheel to select FUNCTION, and press the ENTER/MARK or ►► button.
- 4 Use the wheel to set FUNCTION to DIGI IN (default value: RC-10).
- 5 After completing the setting, press the HOME button to return to the Home Screen.

## 9 – Using the REMOTE/DIGITAL IN jack

### NOTE

If FUNCTION is set to DIGI IN on the REMOTE/DIGI IN setting screen, moving the **INPUT** switch on the top panel will not change the input, and the following popup message will appear.



# 10 – Messages

The following is a list of the popup messages that might appear on the DR-100MKII under certain conditions. Refer to this list if one of these popup messages appears and you want to check the meaning or determine a proper response.

Message	Meaning and response
File Name ERR	The DIVIDE function would cause the file name to exceed 200 characters. The DIVIDE function adds “_a” or “_b” to the end of the original file name. Before choosing the DIVIDE function, connect the unit to a computer and edit the file name to less than 198 characters.
Dup File Name	The DIVIDE function would cause the file name to be the same as that of an existing file. The DIVIDE function adds “_a” or “_b” to the end of the original file name. Before choosing the DIVIDE function, connect the unit to a computer and edit the file name.
File Not Found	The file added to the playlist cannot be found or a file could be damaged. Please check the file in question.
Non-Supported	The audio file is not a supported format. Please see "7 - Connecting with a computer" for file formats that this unit can use.
Battery Empty	The battery is almost out of power. Recharge the lithium-ion battery and/or replace the AA batteries.
I/O Too Short	The IN and OUT points are too close together. Reset the IN and OUT points with at least 1 second between them.
File Not Found PLAYLIST	The file in the Playlist cannot be found. Please confirm that the file is still in the Music Folder.
No PLAYLIST	No files have been added to the Playlist. Add a file to the Playlist or change the play mode to something besides PLAYLIST.
PLAYLIST Full	The playlist is full. You cannot add more than 99 files to the Playlist.
MBR Error Init CARD	The card is not formatted properly or the formatting is broken. Change the card or press the ENTER/MARK button when this message appears to format the card in FAT format. <b>CAUTION:</b> Execution of FAT formatting erases all data currently on the card.
Format Error Format CARD	The FAT formatting of the card is abnormal or broken. This message also appears if you FAT formatted the card using a computer connected by USB and if a new card is inserted in the unit. Always use the DR-100MKII to conduct FAT formatting of cards to be used with it. Change the card or press the ENTER/MARK button when this message appears to format the card in FAT format. <b>CAUTION:</b> Execution of FAT formatting erases all data currently on the card.
File Not Found Make Sys File	The system file is missing. This unit requires a system file for operation. When this message appears, press the ENTER/MARK button to automatically create a system file.
Invalid SysFile Make Sys File	The system file required to operate this unit is invalid. When this message appears, press the ENTER/MARK button to automatically create a system file.
Invalid Card Change Card	Something might be wrong with the card. Change the card.
Protected Card Change Card	This appears when the card is protected and lacks the necessary Music Folder and other folders and files. Unlock the write protect switch, restart the power and format the card.
Write Timeout	Writing to the card timed out. Backup files on the card to your computer, and format the card.
Card Full	The card has no remaining capacity. Erase unnecessary files or move them to your computer to make open space.
Layer too Deep	Folders can be created down to two layers. You cannot create a new folder inside the current folder.
Can't Divide	The position selected for divide is not suitable (too close to the beginning or end of a file).
Max File Size	The file is larger than the designated size or the recording time exceeded 24 hours.
File Full	The total number of folders and files exceeds 999. Erase unnecessary files or move them to your computer.
Card Error	The card could not be handled properly. Replace the card.
Current File MP3	MP3 files cannot be divided.
File Protected	The file is read only and cannot be erased.
No Card	No SD card is in the unit. Install a recordable SD card.

Message	Meaning and response
No PB File	There is no file that can be played back. The file might be damaged.
No MUSIC File	There is no playback file, so DIVIDE and OVERDUB cannot be executed.
Sample Rate 96kHz	96 kHz WAV files cannot be overdubbed.
DIN Selected	When the <b>REMOTE/DIGITAL IN</b> jack is selected as the input, you cannot change to an analog input even if you change that <b>INPUT</b> switch on the top panel.
DIN Unlock	The <b>REMOTE/DIGITAL IN</b> jack is selected as the input, but the digital input connection has been broken or the sampling frequency does not match. Confirm that the external digital audio equipment is properly connected to the <b>REMOTE/DIGITAL IN</b> jack. Confirm also that the sampling frequencies of this recorder and the external digital audio equipment are matched. Press the <b>STOP [■]</b> button to close this message. When this error occurs, the input from the <b>REMOTE/DIGITAL IN</b> jack cannot be used, but recording is possible. If this message appears during recording, noise might occur in the recording
Not Continued	
File Error	
Can't Save Data	
Player Error	
Device Error	
Writing Failed	
Sys Rom Err	
Remote Cmd	If one of these errors occurs, turn the unit's power OFF and then ON again.
Remote Rx	If you are unable to turn the power OFF, remove the batteries and disconnect any TASCAM PS-P520AC adaptor (sold separately) or TASCAM BP-6AA external battery pack (sold separately) being used.
System Err 50	
System Error 1	If the error message continues to appear frequently, please contact the dealer where the product was purchased from or the TASCAM Distributor in your area.
System Error 2	
System Error 3	
System Error 4	
System Error 5	
System Error 6	
System Error 7	
System Error 8	
System Error 9	

# 11 – Troubleshooting

If you are having trouble with the operation of this unit, please try the following before seeking repair. If these measures do not solve the problem, please contact the dealer where the product was purchased from or the TASCAM Distributor in your area.

## ■ Power will not turn ON.

- Confirm that the batteries are not dead.
- Confirm that the batteries are installed with the correct +/- orientation.
- Confirm that the power plug of the AC adaptor (TASCAM PS-P520: sold separately) is securely inserted.
- Is a TASCAM BP-L2 lithium-ion battery installed?

## ■ The lithium-ion battery cannot be charged fully.

Is the unit becoming warm?

If the unit is used for a long time in a high-temperature environment, its internal temperature will increase, causing the protection circuits of the lithium-ion battery to function and stop recharging.

Recharge the battery at a suitable temperature (room temperature of 30°C or less).

## ■ I cannot operate the recorder with the remote control

Make sure the battery is in the remote control and that it has power remaining.

## ■ The unit does not function.

- Confirm that the **HOLD** switch is not set in the direction of the arrow.
- Is the unit connected to a PC with the USB cable? (Is USB connected shown on the display?)

## ■ The SD card is not recognized.

Confirm that the SD card is inserted completely.

## ■ Playback does not work.

- Please check the operation mode again.
- If you are trying to play a WAV file, confirm that the sampling frequency is supported by this unit.
- If you are trying to play an MP3 file, confirm that its bit rate and sampling frequency are supported by this unit. (See "Selecting file format, sampling frequency, and maximum file size" on page 27.)

## ■ No sound is output.

- Are headphones connected?
- Is the **SPEAKER** switch **OFF**?
- Check the connections with the monitoring system.
- Is the volume of the monitoring system minimized?
- Is the **OUTPUT LEVEL** setting of the unit minimized?
- On the **INPUT SETTING** screen, is the **MONITOR** item set to **ON**, enabling monitoring of the input signal?

## ■ Recording does not work.

- Please check the operation mode again.
- If you are using an external device, check the connection again.

- Check the input settings again.
- Confirm that the analog input level is not too low.
- Confirm that the SD card is not full.
- Does the card already contain the maximum number of files (999 folders and files total)?

## ■ The analog input level is low.

- Confirm that the analog input level setting is not too low.
- Confirm that the output level of a connected external device is not too low.

## ■ The sound I am trying to record sounds distorted.

Is the analog input level (INPUT LEVEL) setting low and the input gain setting high?

## ■ The playback sounds unnatural.

- Check to see if the playback pitch has been changed.
- Confirm that the playback speed is not being adjusted.

## ■ I cannot erase a file.

- Is the SD card write-protect switch engaged?
- Are you trying to erase a copy of a file that has been set to read-only on a computer?

## ■ This unit's files do not appear on the computer.

- Confirm that the unit is connected to the computer using its USB port.
- Confirm that USB hubs are not used.
- Confirm that the unit is not recording or in recording standby mode.

# 12 – Specifications

---

## Ratings

---

### Recording media

SD cards (64 MB–2 GB) and SDHC cards (4 GB–32 GB)

### Recording/playback format

WAV: 44.1/48/96 (HS mode) kHz, 16/24-bit

MP3: 44.1/48 kHz, 32/64/96/128/192/256/320 kbps

### Number of channels

2 channels (stereo)

---

## Input/output ratings

---

### Analog audio input/output ratings

#### XLR (MIC/LINE 1) IN connectors (Phantom power compatible)

Connectors: XLR-3-31 (1: GND, 2: HOT, 3: COLD)

##### When MIC/LINE 1 switch is set to MIC

Input impedance: 2.1 k $\Omega$

- When GAIN HIGH  
Nominal input level: –70 dBu  
Maximum input level: –54 dBu
- When GAIN MID  
Nominal input level: –42 dBu  
Maximum input level: –26 dBu
- When GAIN LOW  
Nominal input level: –14 dBu  
Maximum input level: +2 dBu

##### When MIC/LINE 1 switch is set to LINE 1

Input impedance: 2.5 k $\Omega$   
Nominal input level: +4 dBu  
Maximum input level: +24 dBu

#### LINE 2 IN jack

Connector: 1/8" (3.5 mm) stereo mini jack  
Input impedance: 22 k $\Omega$  or more  
Nominal input level: –10 dBV  
Maximum input level: +6 dBV

#### LINE OUT jack

Connector: 1/8" (3.5 mm) stereo mini jack  
Output impedance: 200 $\Omega$   
XLR LINE 1 IN:  
Nominal output level: –14 dBV  
Maximum output level: +6 dBV  
Others:  
Nominal output level: –10 dBV  
Maximum output level: +6 dBV

#### jack

Connector: 1/8" (3.5 mm) stereo mini jack  
Maximum output : 25 mW + 25 mW  
(with 32 $\Omega$  headphone connection)

#### Built-in speaker

Output: 0.4 W (mono)

---

### Digital audio input ratings

#### DIGITAL IN jack

Connector: 3/32" (2.5 mm) TRS jack (using the conversion cable made for this unit)

Format: IEC60958-3 (S/PDIF)

---

### Control input/output ratings

#### USB port

Connector: Mini-B type

Format: USB 2.0 HIGH SPEED mass storage class

#### REMOTE jack

Connector: 3/32" (2.5 mm) TRS jack

---

## Audio performance

---

### Frequency response

20 Hz–20 kHz, +1/–3 dB  
(EXT IN to LINE OUT, Fs 44.1 kHz, JEITA)

20 Hz–22 kHz, +1/–3 dB  
(EXT IN to LINE OUT, Fs 48 kHz, JEITA)

20 Hz–40 kHz, +1/–3 dB  
(EXT IN to LINE OUT, Fs 96 kHz, JEITA)

### Distortion

Less than 0.01%

(XLR LINE 1 IN to LINE OUT, Fs 44.1 kHz, +24 dBu input, JEITA)

### S/N ratio

92 dB or more

(XLR LINE 1 IN TO LINE OUT, Fs 44.1 kHz, +24 dBu input, JEITA)

Note) JEITA: Conforming to JEITA CP-2150

---

## Requirements for connected computers

---

Check the TASCAM website (<http://tascam.com/>) for information about the latest operating system compatibility.

### Windows

Pentium 300 MHz or better

128 MB or more memory

USB port (USB 2.0)

### Macintosh

266 MHz Power PC, iMac, G3, G4 or better

64MB or more memory

USB port (USB 2.0 recommended)



# 12 – Specifications

## Recommended USB host controller

Intel chipset

## Supported OS

Windows: Windows XP, Windows Vista, Windows 7

Macintosh: Mac OS X 10.2 or newer

## General

### Power supply

Lithium-ion rechargeable battery made for this unit (TASCAM BP-L2)

Two AA batteries (Alkaline or Ni-MH batteries)

AC adaptor (TASCAM PS-P520, sold separately)

External battery pack (TASCAM BP-6AA, sold separately)

### Power consumption:

4 W (maximum)

### Battery life (continuous operation):

Lithium ion battery (BP-L2):

Format	Continuous operation time	Note
Playback, WAV, 44.1 kHz, 16 bit	About 5 hours	Headphones (32Ω)
Playback, WAV, 44.1 kHz, 16 bit	About 5 hours	Built-in speaker
Playback, MP3, 44.1 kHz, 128 kbps	About 5 hours	Headphones (32Ω)
Playback, MP3, 44.1 kHz, 128 kbps	About 5 hours	Built-in speaker
Recording, WAV, 44.1 kHz, 16 bit	About 5 hours	Built-in mics (UNI/OMNI)
Recording, MP3, 44.1 kHz, 128 kbps	About 5 hours	Built-in mics (UNI/OMNI)

JEITA Recording/Playback

### Ni-MH batteries (eneloop):

Format	Continuous operation time	Note
Playback, WAV, 44.1 kHz, 16 bit	About 4 hours	Headphones (32Ω)
Playback, WAV, 44.1 kHz, 16 bit	About 4 hours	Built-in speaker
Playback, MP3, 44.1 kHz, 128 kbps	About 4 hours	Headphones (32Ω)
Playback, MP3, 44.1 kHz, 128 kbps	About 4 hours	Built-in speaker
Recording, WAV, 44.1 kHz, 16 bit	About 4 hours	Built-in mics (UNI/OMNI)
Recording, MP3, 44.1 kHz, 128 kbps	About 4 hours	Built-in mics (UNI/OMNI)

JEITA Recording/Playback

### Alkaline batteries (EVOLTA):

Format	Continuous operation time	Note
Playback, WAV, 44.1 kHz, 16 bit	About 2 hours 45 minutes	Headphones (32Ω)
Playback, WAV, 44.1 kHz, 16 bit	About 2 hours 45 minutes	Built-in speaker
Playback, MP3, 44.1 kHz, 128 kbps	About 2 hours 45 minutes	Headphones (32Ω)
Playback, MP3, 44.1 kHz, 128 kbps	About 2 hours 45 minutes	Built-in speaker
Recording, WAV, 44.1 kHz, 16 bit	About 2 hours 45 minutes	Built-in mics (UNI/OMNI)
Recording, MP3, 44.1 kHz, 128 kbps	About 2 hours 45 minutes	Built-in mics (UNI/OMNI)

JEITA Recording/Playback

### External dimensions (WHD, excluding protrusions):

80 x 153 x 35 mm/3.15 x 6.024 x 1.378 in.

### Weight:

290 g/10.23 oz (not including batteries)

### Operation temperature range:

0–40°C/32–104°F

0–30° C/32–86°F (when recharging lithium ion batteries)

## Dimensional drawing

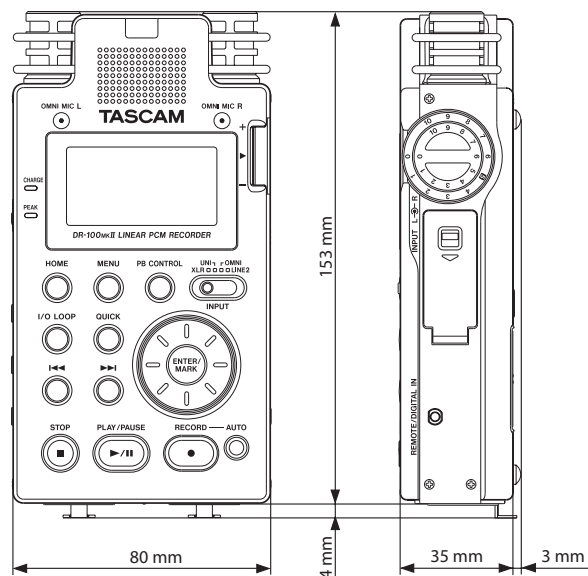

- Illustrations and other depictions may differ in part from the actual product.
- Specifications and external appearance may be changed without notification to improve the product.



# TASCAM

## DR-100mkII

### User registration

Customers in the USA, please visit the TASCAM website (<http://tascam.com/>) to register as a user online.

#### TEAC CORPORATION

Phone: +81-42-356-9143

1-47 Ochiai, Tama-shi, Tokyo 206-8530, Japan

<http://tascam.jp/>

---

#### TEAC AMERICA, INC.

Phone: +1-323-726-0303

7733 Telegraph Road, Montebello, California 90640 USA

<http://tascam.com/>

---

#### TEAC CANADA LTD.

Phone: +1905-890-8008 Facsimile: +1905-890-9888

5939 Wallace Street, Mississauga, Ontario L4Z 1Z8, Canada

<http://tascam.com/>

---

#### TEAC MEXICO, S.A. de C.V.

Phone: +52-55-5010-6000

Río Churubusco 364, Colonia Del Carmen, Delegación Coyoacán, CP 04100, México DF, México

<http://www.teacmexico.net/>

---

#### TEAC UK LIMITED

Phone: +44-8451-302511

Suites 19 & 20, Building 6, Croxley Green Business Park, Hatters Lane, Watford, Hertfordshire, WD18 8TE, UK

<http://www.tascam.co.uk/>

---

#### TEAC EUROPE GmbH

Phone: +49-611-71580

Bahnstrasse 12, 65205 Wiesbaden-Erbenheim, Germany

<http://tascam.de/>